

Ezi-SERVO[®]

Closed Loop Stepping System

Planetary Geared Step Motor

- SHIMPO Planetary Reducer Integrated
- Extremely Low Backlash & High Precision
- High Torque & Rigidity
- Various Reduction Ratio
- Long Life & Maintenance-Free

PG



FASTECH

Fast, Accurate, Smooth Motion

유성감속기 제조원
A Shimpo Group Company
SHIMPO
-All for dreams

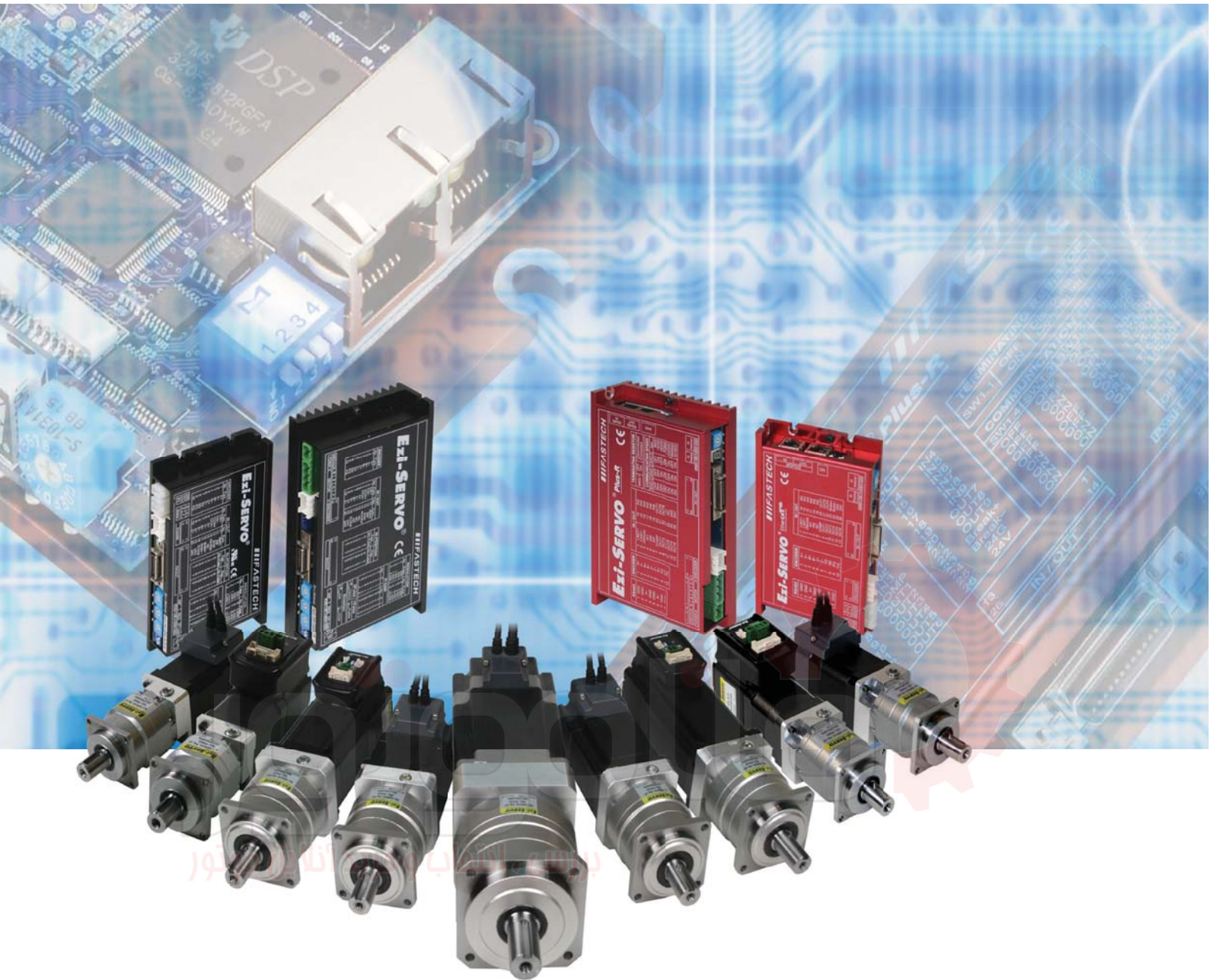

Fast, Accurate, Smooth Motion

Ezi-SERVO[®] PG

Closed Loop Stepping System

1

Ezi-SERVO PG Series Characteristics

• Adopt SHIMPO' s high accuracy planetary gearbox

Ezi-SERVO PG Series, Fastech' s new Planetary Geared Step Motor unit product maximizes User' s operational convenience with integration between Closed Loop Stepping System, Ezi-SERVO and Helical Gear structure of SHIMPO' s high accuracy planetary gearbox has 3 min less Backlash.

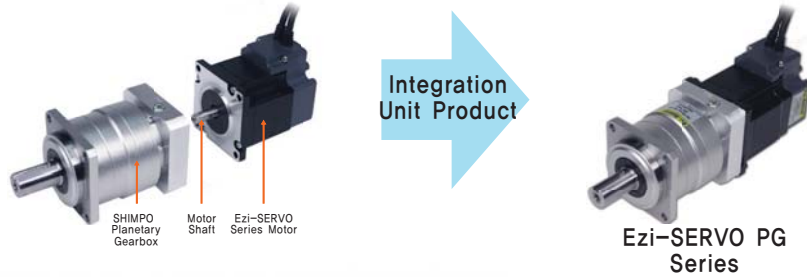

2

Ezi-SERVO PG Series of Advantages

▪ Vibration, Low Noise

Ezi-SERVO PG Series, a High Precision of Helical Gear structured SHIMPO planetary gearbox developed for low vibration and extremely low noise of operation and both of single and double stage of gearboxes generates backlash less than 3min so it would be the best solution for high accuracy of positioning

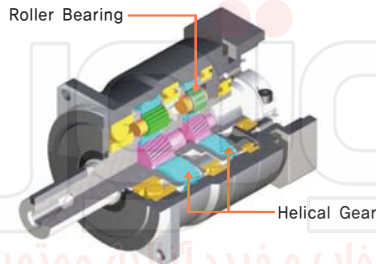

▪ High Rigidity, High Torque

SHIMPO Planetary Gearbox, combined with Ezi-SERVO PG Series, maximized allowable torque with using Needle Roller bearing and machined body to be internal gear so it enables compact design of gearbox and maximized durability.

▪ Resonance Minimization

Ezi-SERVO PG series by applying the planetary gearbox, gear ratio corresponding to the overall operation speed of the stepper motor so low speed that occurs mainly in the resonance of a stepper motor can drive the motor to avoid the band itself and the system is very effective in reducing the vibration.

▪ Long Life & Maintenance Free

Ezi-SERVO PG Series is Maintenance-Free product. No risk of grease leakage because of high viscosity of Anti-separation grease and it is maintenance free products because of lack of necessity for grease replacement



Maintenance-free

▪ Various Gear Ratio

Ezi-SERVO Series, Unit product between a variety of gear ratio of gearbox with closed loop stepper motor, enables to generate various high torque as small capacity of stepper and also can respond under any load with flexibility

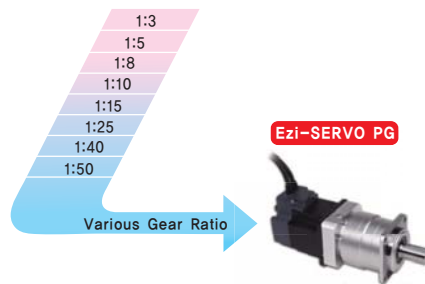





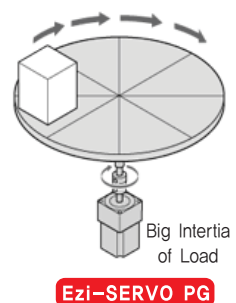



▪ Optimized Solution for Big Inertia of Rotation

Allowable load moment of inertia is proportional to the square of the gear ratio, Gearbox united Ezi-SERVO PG Series enables fast positioning and smooth operation even under big inertia moment of load.



● Ezi-SERVO PG Series Line-Up

Series	Combination	Frame size of Gearbox			
		42mm	60mm	60mm	90mm
		Frame size of Motor			
		42mm	56mm	60mm	86mm
Ezi-SERVO ST Series	Ezi-SERVO Motor + SHIMPO Planetary Gearbox + Ezi-SERVO ST Drive	Will be launched			
Ezi-SERVO PR Series	Ezi-SERVO Motor + SHIMPO Planetary Gearbox + Ezi-SERVO PR Controller/Drive	Will be launched			
Ezi-SERVO BT Series	Ezi-SERVO Motor + SHIMPO Planetary Gearbox + Ezi-SERVO BT Drive	Will be launched			-
Ezi-SERVO ALL Series	Ezi-SERVO Motor + SHIMPO Planetary Gearbox + Ezi-SERVO ALL Controller/Drive	Will be launched		-	-

● Ezi-SERVO PG Series Part Numbering

◆ Ezi-SERVO ST Series

Ezi-SERVO-PG-ST-60M-PN10

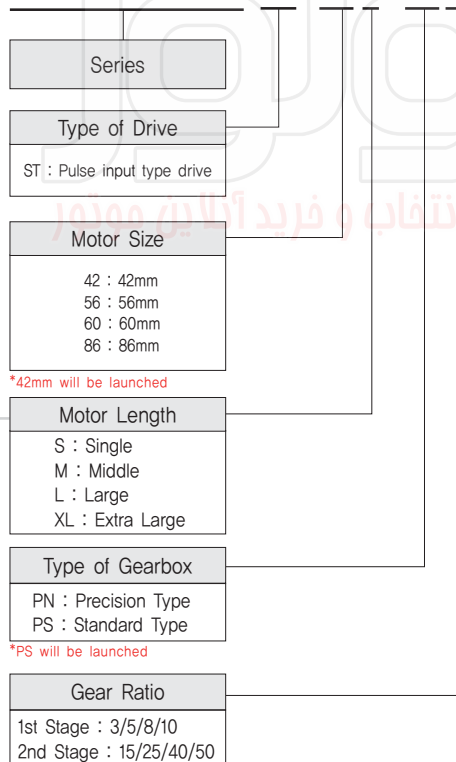

◆ Ezi-SERVO Plus-R Series

Ezi-SERVO-PG-PR-60M-PN10

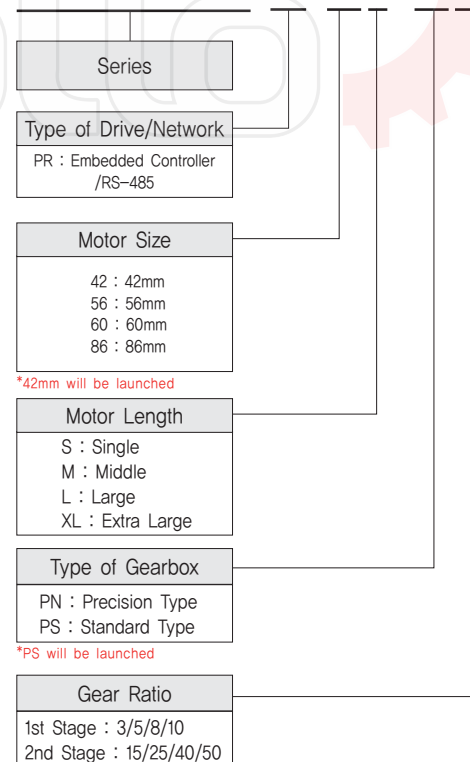

◆ Ezi-SERVO BT Series

Ezi-SERVO-PG-BT-60M-PN10

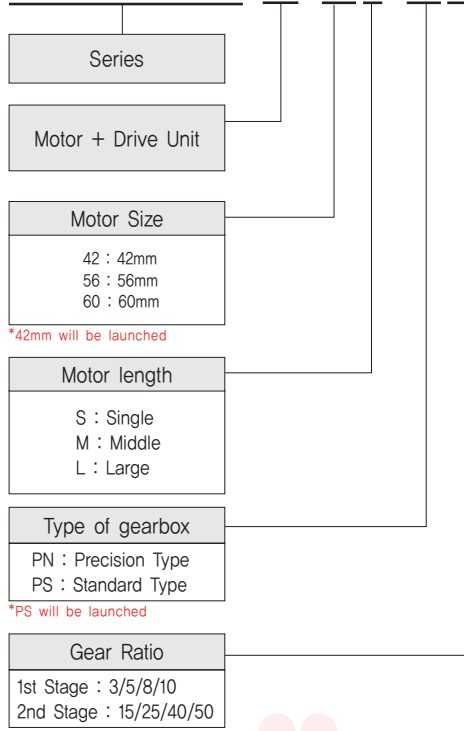

◆ Ezi-SERVO ALL Series

Ezi-SERVO-PG-ALL-60M-PN10

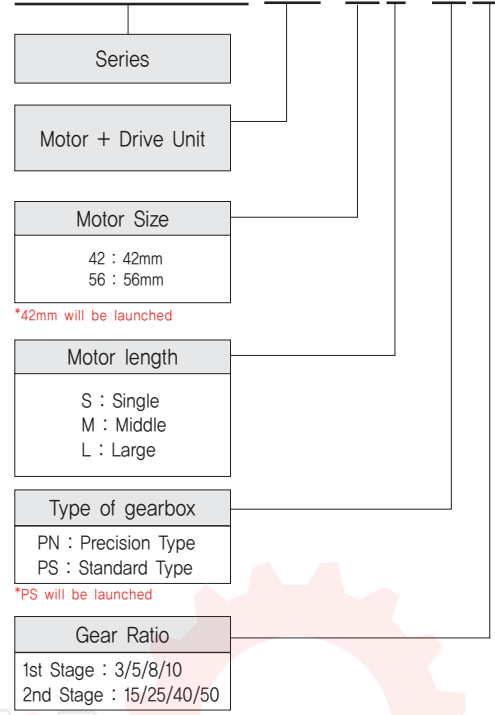

● Type of Ezi-SERVO PG Series

Now officially released for sale Ezi-SERVO PG Series are as follows.

◆ Ezi-SERVO ST Series

Ezi-SERVO ST Series			
Part Number	Combined Drive	Motor Voltage	Gear Ratio
Ezi-SERVO-PG-ST-42S-PN3	EzS-PD-42S-A	24, 40VDC	1:3
Ezi-SERVO-PG-ST-42S-PN5	EzS-PD-42S-A	24, 40VDC	1:5
Ezi-SERVO-PG-ST-42S-PN8	EzS-PD-42S-A	24, 40VDC	1:8
Ezi-SERVO-PG-ST-42S-PN10	EzS-PD-42S-A	24, 40VDC	1:10
Ezi-SERVO-PG-ST-42S-PN15	EzS-PD-42S-A	24, 40VDC	1:15
Ezi-SERVO-PG-ST-42S-PN25	EzS-PD-42S-A	24, 40VDC	1:25
Ezi-SERVO-PG-ST-42S-PN40	EzS-PD-42S-A	24, 40VDC	1:40
Ezi-SERVO-PG-ST-42S-PN50	EzS-PD-42S-A	24, 40VDC	1:50
Ezi-SERVO-PG-ST-42M-PN3	EzS-PD-42M-A	24, 40VDC	1:3
Ezi-SERVO-PG-ST-42M-PN5	EzS-PD-42M-A	24, 40VDC	1:5
Ezi-SERVO-PG-ST-42M-PN8	EzS-PD-42M-A	24, 40VDC	1:8
Ezi-SERVO-PG-ST-42M-PN10	EzS-PD-42M-A	24, 40VDC	1:10
Ezi-SERVO-PG-ST-42M-PN15	EzS-PD-42M-A	24, 40VDC	1:15
Ezi-SERVO-PG-ST-42M-PN25	EzS-PD-42M-A	24, 40VDC	1:25
Ezi-SERVO-PG-ST-42M-PN40	EzS-PD-42M-A	24, 40VDC	1:40
Ezi-SERVO-PG-ST-42M-PN50	EzS-PD-42M-A	24, 40VDC	1:50
Ezi-SERVO-PG-ST-42L-PN3	EzS-PD-42L-A	24, 40VDC	1:3
Ezi-SERVO-PG-ST-42L-PN5	EzS-PD-42L-A	24, 40VDC	1:5
Ezi-SERVO-PG-ST-42L-PN8	EzS-PD-42L-A	24, 40VDC	1:8
Ezi-SERVO-PG-ST-42L-PN10	EzS-PD-42L-A	24, 40VDC	1:10
Ezi-SERVO-PG-ST-42L-PN15	EzS-PD-42L-A	24, 40VDC	1:15
Ezi-SERVO-PG-ST-42L-PN25	EzS-PD-42L-A	24, 40VDC	1:25
Ezi-SERVO-PG-ST-42L-PN40	EzS-PD-42L-A	24, 40VDC	1:40
Ezi-SERVO-PG-ST-42L-PN50	EzS-PD-42L-A	24, 40VDC	1:50
Ezi-SERVO-PG-ST-42XL-PN3	EzS-PD-42XL-A	24, 40VDC	1:3
Ezi-SERVO-PG-ST-42XL-PN5	EzS-PD-42XL-A	24, 40VDC	1:5
Ezi-SERVO-PG-ST-42XL-PN8	EzS-PD-42XL-A	24, 40VDC	1:8
Ezi-SERVO-PG-ST-42XL-PN10	EzS-PD-42XL-A	24, 40VDC	1:10
Ezi-SERVO-PG-ST-42XL-PN15	EzS-PD-42XL-A	24, 40VDC	1:15
Ezi-SERVO-PG-ST-42XL-PN25	EzS-PD-42XL-A	24, 40VDC	1:25
Ezi-SERVO-PG-ST-42XL-PN40	EzS-PD-42XL-A	24, 40VDC	1:40
Ezi-SERVO-PG-ST-42XL-PN50	EzS-PD-42XL-A	24, 40VDC	1:50
Ezi-SERVO-PG-MI-42S-PN3	EzS-PD-MI-42S-A	24VDC Only	1:3
Ezi-SERVO-PG-MI-42S-PN5	EzS-PD-MI-42S-A	24VDC Only	1:5
Ezi-SERVO-PG-MI-42S-PN8	EzS-PD-MI-42S-A	24VDC Only	1:8
Ezi-SERVO-PG-MI-42S-PN10	EzS-PD-MI-42S-A	24VDC Only	1:10
Ezi-SERVO-PG-MI-42S-PN15	EzS-PD-MI-42S-A	24VDC Only	1:15
Ezi-SERVO-PG-MI-42S-PN25	EzS-PD-MI-42S-A	24VDC Only	1:25
Ezi-SERVO-PG-MI-42S-PN40	EzS-PD-MI-42S-A	24VDC Only	1:40
Ezi-SERVO-PG-MI-42S-PN50	EzS-PD-MI-42S-A	24VDC Only	1:50
Ezi-SERVO-PG-MI-42M-PN3	EzS-PD-MI-42M-A	24VDC Only	1:3
Ezi-SERVO-PG-MI-42M-PN5	EzS-PD-MI-42M-A	24VDC Only	1:5
Ezi-SERVO-PG-MI-42M-PN8	EzS-PD-MI-42M-A	24VDC Only	1:8
Ezi-SERVO-PG-MI-42M-PN10	EzS-PD-MI-42M-A	24VDC Only	1:10
Ezi-SERVO-PG-MI-42M-PN15	EzS-PD-MI-42M-A	24VDC Only	1:15
Ezi-SERVO-PG-MI-42M-PN25	EzS-PD-MI-42M-A	24VDC Only	1:25
Ezi-SERVO-PG-MI-42M-PN40	EzS-PD-MI-42M-A	24VDC Only	1:40
Ezi-SERVO-PG-MI-42M-PN50	EzS-PD-MI-42M-A	24VDC Only	1:50
Ezi-SERVO-PG-MI-42L-PN3	EzS-PD-MI-42L-A	24VDC Only	1:3
Ezi-SERVO-PG-MI-42L-PN5	EzS-PD-MI-42L-A	24VDC Only	1:5
Ezi-SERVO-PG-MI-42L-PN8	EzS-PD-MI-42L-A	24VDC Only	1:8
Ezi-SERVO-PG-MI-42L-PN10	EzS-PD-MI-42L-A	24VDC Only	1:10
Ezi-SERVO-PG-MI-42L-PN15	EzS-PD-MI-42L-A	24VDC Only	1:15
Ezi-SERVO-PG-MI-42L-PN25	EzS-PD-MI-42L-A	24VDC Only	1:25
Ezi-SERVO-PG-MI-42L-PN40	EzS-PD-MI-42L-A	24VDC Only	1:40
Ezi-SERVO-PG-MI-42L-PN50	EzS-PD-MI-42L-A	24VDC Only	1:50

Ezi-SERVO ST Series			
Part Number	Combined Drive	Motor Voltage	Gear Ratio
Ezi-SERVO-PG-MI-42XL-PN3	EzS-PD-MI-42XL-A	24VDC Only	1:3
Ezi-SERVO-PG-MI-42XL-PN5	EzS-PD-MI-42XL-A	24VDC Only	1:5
Ezi-SERVO-PG-MI-42XL-PN8	EzS-PD-MI-42XL-A	24VDC Only	1:8
Ezi-SERVO-PG-MI-42XL-PN10	EzS-PD-MI-42XL-A	24VDC Only	1:10
Ezi-SERVO-PG-MI-42XL-PN15	EzS-PD-MI-42XL-A	24VDC Only	1:15
Ezi-SERVO-PG-MI-42XL-PN25	EzS-PD-MI-42XL-A	24VDC Only	1:25
Ezi-SERVO-PG-MI-42XL-PN40	EzS-PD-MI-42XL-A	24VDC Only	1:40
Ezi-SERVO-PG-MI-42XL-PN50	EzS-PD-MI-42XL-A	24VDC Only	1:50
Ezi-SERVO-PG-ST-56S-PN3	EzS-PD-56S-A	24VDC Only	1:3
Ezi-SERVO-PG-ST-56S-PN5	EzS-PD-56S-A	24, 40VDC	1:5
Ezi-SERVO-PG-ST-56S-PN8	EzS-PD-56S-A	24, 40VDC	1:8
Ezi-SERVO-PG-ST-56S-PN10	EzS-PD-56S-A	24, 40VDC	1:10
Ezi-SERVO-PG-ST-56S-PN15	EzS-PD-56S-A	24, 40VDC	1:15
Ezi-SERVO-PG-ST-56S-PN25	EzS-PD-56S-A	24, 40VDC	1:25
Ezi-SERVO-PG-ST-56S-PN40	EzS-PD-56S-A	24, 40VDC	1:40
Ezi-SERVO-PG-ST-56S-PN50	EzS-PD-56S-A	24, 40VDC	1:50
Ezi-SERVO-PG-ST-56M-PN3	EzS-PD-56M-A	24, 40VDC	1:3
Ezi-SERVO-PG-ST-56M-PN5	EzS-PD-56M-A	24, 40VDC	1:5
Ezi-SERVO-PG-ST-56M-PN8	EzS-PD-56M-A	24, 40VDC	1:8
Ezi-SERVO-PG-ST-56M-PN10	EzS-PD-56M-A	24, 40VDC	1:10
Ezi-SERVO-PG-ST-56M-PN15	EzS-PD-56M-A	24, 40VDC	1:15
Ezi-SERVO-PG-ST-56M-PN25	EzS-PD-56M-A	24, 40VDC	1:25
Ezi-SERVO-PG-ST-56M-PN40	EzS-PD-56M-A	24, 40VDC	1:40
Ezi-SERVO-PG-ST-56M-PN50	EzS-PD-56M-A	24, 40VDC	1:50
Ezi-SERVO-PG-ST-56L-PN3	EzS-PD-56L-A	24, 40VDC	1:3
Ezi-SERVO-PG-ST-56L-PN5	EzS-PD-56L-A	24, 40VDC	1:5
Ezi-SERVO-PG-ST-56L-PN8	EzS-PD-56L-A	24, 40VDC	1:8
Ezi-SERVO-PG-ST-56L-PN10	EzS-PD-56L-A	24, 40VDC	1:10
Ezi-SERVO-PG-ST-56L-PN15	EzS-PD-56L-A	24, 40VDC	1:15
Ezi-SERVO-PG-ST-56L-PN25	EzS-PD-56L-A	24, 40VDC	1:25
Ezi-SERVO-PG-ST-56L-PN40	EzS-PD-56L-A	24, 40VDC	1:40
Ezi-SERVO-PG-ST-56L-PN50	EzS-PD-56L-A	24, 40VDC	1:50
Ezi-SERVO-PG-ST-60S-PN3	EzS-PD-60S-A	24, 40VDC	1:3
Ezi-SERVO-PG-ST-60S-PN5	EzS-PD-60S-A	24, 40VDC	1:5
Ezi-SERVO-PG-ST-60S-PN8	EzS-PD-60S-A	24, 40VDC	1:8
Ezi-SERVO-PG-ST-60S-PN10	EzS-PD-60S-A	24, 40VDC	1:10
Ezi-SERVO-PG-ST-60S-PN15	EzS-PD-60S-A	24, 40VDC	1:15
Ezi-SERVO-PG-ST-60S-PN25	EzS-PD-60S-A	24, 40VDC	1:25
Ezi-SERVO-PG-ST-60S-PN40	EzS-PD-60S-A	24, 40VDC	1:40
Ezi-SERVO-PG-ST-60S-PN50	EzS-PD-60S-A	24, 40VDC	1:50
Ezi-SERVO-PG-ST-60M-PN3	EzS-PD-60M-A	24, 40VDC	1:3
Ezi-SERVO-PG-ST-60M-PN5	EzS-PD-60M-A	24, 40VDC	1:5
Ezi-SERVO-PG-ST-60M-PN8	EzS-PD-60M-A	24, 40VDC	1:8
Ezi-SERVO-PG-ST-60M-PN10	EzS-PD-60M-A	24, 40VDC	1:10
Ezi-SERVO-PG-ST-60M-PN15	EzS-PD-60M-A	24, 40VDC	1:15
Ezi-SERVO-PG-ST-60M-PN25	EzS-PD-60M-A	24, 40VDC	1:25
Ezi-SERVO-PG-ST-60M-PN40	EzS-PD-60M-A	24, 40VDC	1:40
Ezi-SERVO-PG-ST-60M-PN50	EzS-PD-60M-A	24, 40VDC	1:50
Ezi-SERVO-PG-ST-60L-PN3	EzS-PD-60L-A	24, 40VDC	1:3
Ezi-SERVO-PG-ST-60L-PN5	EzS-PD-60L-A	24, 40VDC	1:5
Ezi-SERVO-PG-ST-60L-PN8	EzS-PD-60L-A	24, 40VDC	1:8
Ezi-SERVO-PG-ST-60L-PN10	EzS-PD-60L-A	24, 40VDC	1:10
Ezi-SERVO-PG-ST-60L-PN15	EzS-PD-60L-A	24, 40VDC	1:15
Ezi-SERVO-PG-ST-60L-PN25	EzS-PD-60L-A	24, 40VDC	1:25
Ezi-SERVO-PG-ST-60L-PN40	EzS-PD-60L-A	24, 40VDC	1:40
Ezi-SERVO-PG-ST-60L-PN50	EzS-PD-60L-A	24, 40VDC	1:50

● Type of Ezi-SERVO PG Series

Now officially released for sale Ezi-SERVO PG Series are as follows.

Ezi-SERVO ST Series			
Part Number	Combined Drive	Motor Voltage	Gear Ratio
Ezi-SERVO-PG-ST-86M-PN3	EzS-PD-86M-A	70VDC	1:3
Ezi-SERVO-PG-ST-86M-PN5	EzS-PD-86M-A	70VDC	1:5
Ezi-SERVO-PG-ST-86M-PN8	EzS-PD-86M-A	70VDC	1:8
Ezi-SERVO-PG-ST-86M-PN10	EzS-PD-86M-A	70VDC	1:10
Ezi-SERVO-PG-ST-86M-PN15	EzS-PD-86M-A	70VDC	1:15
Ezi-SERVO-PG-ST-86M-PN25	EzS-PD-86M-A	70VDC	1:25
Ezi-SERVO-PG-ST-86M-PN40	EzS-PD-86M-A	70VDC	1:40
Ezi-SERVO-PG-ST-86M-PN50	EzS-PD-86M-A	70VDC	1:50
Ezi-SERVO-PG-ST-86L-PN3	EzS-PD-86L-A	70VDC	1:3
Ezi-SERVO-PG-ST-86L-PN5	EzS-PD-86L-A	70VDC	1:5
Ezi-SERVO-PG-ST-86L-PN8	EzS-PD-86L-A	70VDC	1:8
Ezi-SERVO-PG-ST-86L-PN10	EzS-PD-86L-A	70VDC	1:10
Ezi-SERVO-PG-ST-86L-PN15	EzS-PD-86L-A	70VDC	1:15
Ezi-SERVO-PG-ST-86L-PN25	EzS-PD-86L-A	70VDC	1:25
Ezi-SERVO-PG-ST-86L-PN40	EzS-PD-86L-A	70VDC	1:40
Ezi-SERVO-PG-ST-86L-PN50	EzS-PD-86L-A	70VDC	1:50
Ezi-SERVO-PG-ST-86XL-PN3	EzS-PD-86XL-A	70VDC	1:3
Ezi-SERVO-PG-ST-86XL-PN5	EzS-PD-86XL-A	70VDC	1:5
Ezi-SERVO-PG-ST-86XL-PN8	EzS-PD-86XL-A	70VDC	1:8
Ezi-SERVO-PG-ST-86XL-PN10	EzS-PD-86XL-A	70VDC	1:10
Ezi-SERVO-PG-ST-86XL-PN15	EzS-PD-86XL-A	70VDC	1:15
Ezi-SERVO-PG-ST-86XL-PN25	EzS-PD-86XL-A	70VDC	1:25
Ezi-SERVO-PG-ST-86XL-PN40	EzS-PD-86XL-A	70VDC	1:40
Ezi-SERVO-PG-ST-86XL-PN50	EzS-PD-86XL-A	70VDC	1:50

بررسی، انتخاب و فرید آنلاین موتور

● Type of Ezi-SERVO PG Series

Now officially released for sale Ezi-SERVO PG Series are as follows.

◆ Ezi-SERVO Plus-R Series

Ezi-SERVO Plus-R Series			
Part Number	Combined Drive	Motor Voltage	Gear Ratio
Ezi-SERVO-PG-PR-42S-PN3	EzS-NDR-42S-A	24, 40VDC	1:3
Ezi-SERVO-PG-PR-42S-PN5	EzS-NDR-42S-A	24, 40VDC	1:5
Ezi-SERVO-PG-PR-42S-PN8	EzS-NDR-42S-A	24, 40VDC	1:8
Ezi-SERVO-PG-PR-42S-PN10	EzS-NDR-42S-A	24, 40VDC	1:10
Ezi-SERVO-PG-PR-42S-PN15	EzS-NDR-42S-A	24, 40VDC	1:15
Ezi-SERVO-PG-PR-42S-PN25	EzS-NDR-42S-A	24, 40VDC	1:25
Ezi-SERVO-PG-PR-42S-PN40	EzS-NDR-42S-A	24, 40VDC	1:40
Ezi-SERVO-PG-PR-42S-PN50	EzS-NDR-42S-A	24, 40VDC	1:50
Ezi-SERVO-PG-PR-42M-PN3	EzS-NDR-42M-A	24, 40VDC	1:3
Ezi-SERVO-PG-PR-42M-PN5	EzS-NDR-42M-A	24, 40VDC	1:5
Ezi-SERVO-PG-PR-42M-PN8	EzS-NDR-42M-A	24, 40VDC	1:8
Ezi-SERVO-PG-PR-42M-PN10	EzS-NDR-42M-A	24, 40VDC	1:10
Ezi-SERVO-PG-PR-42M-PN15	EzS-NDR-42M-A	24, 40VDC	1:15
Ezi-SERVO-PG-PR-42M-PN25	EzS-NDR-42M-A	24, 40VDC	1:25
Ezi-SERVO-PG-PR-42M-PN40	EzS-NDR-42M-A	24, 40VDC	1:40
Ezi-SERVO-PG-PR-42M-PN50	EzS-NDR-42M-A	24, 40VDC	1:50
Ezi-SERVO-PG-PR-42L-PN3	EzS-NDR-42L-A	24, 40VDC	1:3
Ezi-SERVO-PG-PR-42L-PN5	EzS-NDR-42L-A	24, 40VDC	1:5
Ezi-SERVO-PG-PR-42L-PN8	EzS-NDR-42L-A	24, 40VDC	1:8
Ezi-SERVO-PG-PR-42L-PN10	EzS-NDR-42L-A	24, 40VDC	1:10
Ezi-SERVO-PG-PR-42L-PN15	EzS-NDR-42L-A	24, 40VDC	1:15
Ezi-SERVO-PG-PR-42L-PN25	EzS-NDR-42L-A	24, 40VDC	1:25
Ezi-SERVO-PG-PR-42L-PN40	EzS-NDR-42L-A	24, 40VDC	1:40
Ezi-SERVO-PG-PR-42L-PN50	EzS-NDR-42L-A	24, 40VDC	1:50
Ezi-SERVO-PG-PR-42XL-PN3	EzS-NDR-42XL-A	24, 40VDC	1:3
Ezi-SERVO-PG-PR-42XL-PN5	EzS-NDR-42XL-A	24, 40VDC	1:5
Ezi-SERVO-PG-PR-42XL-PN8	EzS-NDR-42XL-A	24, 40VDC	1:8
Ezi-SERVO-PG-PR-42XL-PN10	EzS-NDR-42XL-A	24, 40VDC	1:10
Ezi-SERVO-PG-PR-42XL-PN15	EzS-NDR-42XL-A	24, 40VDC	1:15
Ezi-SERVO-PG-PR-42XL-PN25	EzS-NDR-42XL-A	24, 40VDC	1:25
Ezi-SERVO-PG-PR-42XL-PN40	EzS-NDR-42XL-A	24, 40VDC	1:40
Ezi-SERVO-PG-PR-42XL-PN50	EzS-NDR-42XL-A	24, 40VDC	1:50
Ezi-SERVO-PG-MI-PR-42S-PN3	EzS-NDR-MI-42S-A	24VDC Only	1:3
Ezi-SERVO-PG-MI-PR-42S-PN5	EzS-NDR-MI-42S-A	24VDC Only	1:5
Ezi-SERVO-PG-MI-PR-42S-PN8	EzS-NDR-MI-42S-A	24VDC Only	1:8
Ezi-SERVO-PG-MI-PR-42S-PN10	EzS-NDR-MI-42S-A	24VDC Only	1:10
Ezi-SERVO-PG-MI-PR-42S-PN15	EzS-NDR-MI-42S-A	24VDC Only	1:15
Ezi-SERVO-PG-MI-PR-42S-PN25	EzS-NDR-MI-42S-A	24VDC Only	1:25
Ezi-SERVO-PG-MI-PR-42S-PN40	EzS-NDR-MI-42S-A	24VDC Only	1:40
Ezi-SERVO-PG-MI-PR-42S-PN50	EzS-NDR-MI-42S-A	24VDC Only	1:50
Ezi-SERVO-PG-MI-PR-42M-PN3	EzS-NDR-MI-42M-A	24VDC Only	1:3
Ezi-SERVO-PG-MI-PR-42M-PN5	EzS-NDR-MI-42M-A	24VDC Only	1:5
Ezi-SERVO-PG-MI-PR-42M-PN8	EzS-NDR-MI-42M-A	24VDC Only	1:8
Ezi-SERVO-PG-MI-PR-42M-PN10	EzS-NDR-MI-42M-A	24VDC Only	1:10
Ezi-SERVO-PG-MI-PR-42M-PN15	EzS-NDR-MI-42M-A	24VDC Only	1:15
Ezi-SERVO-PG-MI-PR-42M-PN25	EzS-NDR-MI-42M-A	24VDC Only	1:25
Ezi-SERVO-PG-MI-PR-42M-PN40	EzS-NDR-MI-42M-A	24VDC Only	1:40
Ezi-SERVO-PG-MI-PR-42M-PN50	EzS-NDR-MI-42M-A	24VDC Only	1:50
Ezi-SERVO-PG-MI-PR-42L-PN3	EzS-NDR-MI-42L-A	24VDC Only	1:3
Ezi-SERVO-PG-MI-PR-42L-PN5	EzS-NDR-MI-42L-A	24VDC Only	1:5
Ezi-SERVO-PG-MI-PR-42L-PN8	EzS-NDR-MI-42L-A	24VDC Only	1:8
Ezi-SERVO-PG-MI-PR-42L-PN10	EzS-NDR-MI-42L-A	24VDC Only	1:10
Ezi-SERVO-PG-MI-PR-42L-PN15	EzS-NDR-MI-42L-A	24VDC Only	1:15
Ezi-SERVO-PG-MI-PR-42L-PN25	EzS-NDR-MI-42L-A	24VDC Only	1:25
Ezi-SERVO-PG-MI-PR-42L-PN40	EzS-NDR-MI-42L-A	24VDC Only	1:40
Ezi-SERVO-PG-MI-PR-42L-PN50	EzS-NDR-MI-42L-A	24VDC Only	1:50

Ezi-SERVO Plus-R Series			
Part Number	Combined Drive	Motor Voltage	Gear Ratio
Ezi-SERVO-PG-MI-PR-42XL-PN3	EzS-NDR-MI-42XL-A	24VDC Only	1:3
Ezi-SERVO-PG-MI-PR-42XL-PN5	EzS-NDR-MI-42XL-A	24VDC Only	1:5
Ezi-SERVO-PG-MI-PR-42XL-PN8	EzS-NDR-MI-42XL-A	24VDC Only	1:8
Ezi-SERVO-PG-MI-PR-42XL-PN10	EzS-NDR-MI-42XL-A	24VDC Only	1:10
Ezi-SERVO-PG-MI-PR-42XL-PN15	EzS-NDR-MI-42XL-A	24VDC Only	1:15
Ezi-SERVO-PG-MI-PR-42XL-PN25	EzS-NDR-MI-42XL-A	24VDC Only	1:25
Ezi-SERVO-PG-MI-PR-42XL-PN40	EzS-NDR-MI-42XL-A	24VDC Only	1:40
Ezi-SERVO-PG-MI-PR-42XL-PN50	EzS-NDR-MI-42XL-A	24VDC Only	1:50
Ezi-SERVO-PG-PR-56S-PN3	EzS-NDR-56S-A	24, 40VDC	1:3
Ezi-SERVO-PG-PR-56S-PN5	EzS-NDR-56S-A	24, 40VDC	1:5
Ezi-SERVO-PG-PR-56S-PN8	EzS-NDR-56S-A	24, 40VDC	1:8
Ezi-SERVO-PG-PR-56S-PN10	EzS-NDR-56S-A	24, 40VDC	1:10
Ezi-SERVO-PG-PR-56S-PN15	EzS-NDR-56S-A	24, 40VDC	1:15
Ezi-SERVO-PG-PR-56S-PN25	EzS-NDR-56S-A	24, 40VDC	1:25
Ezi-SERVO-PG-PR-56S-PN40	EzS-NDR-56S-A	24, 40VDC	1:40
Ezi-SERVO-PG-PR-56S-PN50	EzS-NDR-56S-A	24, 40VDC	1:50
Ezi-SERVO-PG-PR-56M-PN3	EzS-NDR-56M-A	24, 40VDC	1:3
Ezi-SERVO-PG-PR-56M-PN5	EzS-NDR-56M-A	24, 40VDC	1:5
Ezi-SERVO-PG-PR-56M-PN8	EzS-NDR-56M-A	24, 40VDC	1:8
Ezi-SERVO-PG-PR-56M-PN10	EzS-NDR-56M-A	24, 40VDC	1:10
Ezi-SERVO-PG-PR-56M-PN15	EzS-NDR-56M-A	24, 40VDC	1:15
Ezi-SERVO-PG-PR-56M-PN25	EzS-NDR-56M-A	24, 40VDC	1:25
Ezi-SERVO-PG-PR-56M-PN40	EzS-NDR-56M-A	24, 40VDC	1:40
Ezi-SERVO-PG-PR-56M-PN50	EzS-NDR-56M-A	24, 40VDC	1:50
Ezi-SERVO-PG-PR-56L-PN3	EzS-NDR-56L-A	24, 40VDC	1:3
Ezi-SERVO-PG-PR-56L-PN5	EzS-NDR-56L-A	24, 40VDC	1:5
Ezi-SERVO-PG-PR-56L-PN8	EzS-NDR-56L-A	24, 40VDC	1:8
Ezi-SERVO-PG-PR-56L-PN10	EzS-NDR-56L-A	24, 40VDC	1:10
Ezi-SERVO-PG-PR-56L-PN15	EzS-NDR-56L-A	24, 40VDC	1:15
Ezi-SERVO-PG-PR-56L-PN25	EzS-NDR-56L-A	24, 40VDC	1:25
Ezi-SERVO-PG-PR-56L-PN40	EzS-NDR-56L-A	24, 40VDC	1:40
Ezi-SERVO-PG-PR-56L-PN50	EzS-NDR-56L-A	24, 40VDC	1:50
Ezi-SERVO-PG-PR-60S-PN3	EzS-NDR-60S-A	24, 40VDC	1:3
Ezi-SERVO-PG-PR-60S-PN5	EzS-NDR-60S-A	24, 40VDC	1:5
Ezi-SERVO-PG-PR-60S-PN8	EzS-NDR-60S-A	24, 40VDC	1:8
Ezi-SERVO-PG-PR-60S-PN10	EzS-NDR-60S-A	24, 40VDC	1:10
Ezi-SERVO-PG-PR-60S-PN15	EzS-NDR-60S-A	24, 40VDC	1:15
Ezi-SERVO-PG-PR-60S-PN25	EzS-NDR-60S-A	24, 40VDC	1:25
Ezi-SERVO-PG-PR-60S-PN40	EzS-NDR-60S-A	24, 40VDC	1:40
Ezi-SERVO-PG-PR-60S-PN50	EzS-NDR-60S-A	24, 40VDC	1:50
Ezi-SERVO-PG-PR-60M-PN3	EzS-NDR-60M-A	24, 40VDC	1:3
Ezi-SERVO-PG-PR-60M-PN5	EzS-NDR-60M-A	24, 40VDC	1:5
Ezi-SERVO-PG-PR-60M-PN8	EzS-NDR-60M-A	24, 40VDC	1:8
Ezi-SERVO-PG-PR-60M-PN10	EzS-NDR-60M-A	24, 40VDC	1:10
Ezi-SERVO-PG-PR-60M-PN15	EzS-NDR-60M-A	24, 40VDC	1:15
Ezi-SERVO-PG-PR-60M-PN25	EzS-NDR-60M-A	24, 40VDC	1:25
Ezi-SERVO-PG-PR-60M-PN40	EzS-NDR-60M-A	24, 40VDC	1:40
Ezi-SERVO-PG-PR-60M-PN50	EzS-NDR-60M-A	24, 40VDC	1:50
Ezi-SERVO-PG-PR-60L-PN3	EzS-NDR-60L-A	24, 40VDC	1:3
Ezi-SERVO-PG-PR-60L-PN5	EzS-NDR-60L-A	24, 40VDC	1:5
Ezi-SERVO-PG-PR-60L-PN8	EzS-NDR-60L-A	24, 40VDC	1:8
Ezi-SERVO-PG-PR-60L-PN10	EzS-NDR-60L-A	24, 40VDC	1:10
Ezi-SERVO-PG-PR-60L-PN15	EzS-NDR-60L-A	24, 40VDC	1:15
Ezi-SERVO-PG-PR-60L-PN25	EzS-NDR-60L-A	24, 40VDC	1:25
Ezi-SERVO-PG-PR-60L-PN40	EzS-NDR-60L-A	24, 40VDC	1:40
Ezi-SERVO-PG-PR-60L-PN50	EzS-NDR-60L-A	24, 40VDC	1:50

● Type of Ezi-SERVO PG Series

Now officially released for sale Ezi-SERVO PG Series are as follows.

Ezi-SERVO Plus-R Series			
Part Number	Combined Drive	Motor Voltage	Gear Ratio
Ezi-SERVO-PG-PR-86M-PN3	EzS-NDR-86M-A	70VDC	1:3
Ezi-SERVO-PG-PR-86M-PN5	EzS-NDR-86M-A	70VDC	1:5
Ezi-SERVO-PG-PR-86M-PN8	EzS-NDR-86M-A	70VDC	1:8
Ezi-SERVO-PG-PR-86M-PN10	EzS-NDR-86M-A	70VDC	1:10
Ezi-SERVO-PG-PR-86M-PN15	EzS-NDR-86M-A	70VDC	1:15
Ezi-SERVO-PG-PR-86M-PN25	EzS-NDR-86M-A	70VDC	1:25
Ezi-SERVO-PG-PR-86M-PN40	EzS-NDR-86M-A	70VDC	1:40
Ezi-SERVO-PG-PR-86M-PN50	EzS-NDR-86M-A	70VDC	1:50
Ezi-SERVO-PG-PR-86L-PN3	EzS-NDR-86L-A	70VDC	1:3
Ezi-SERVO-PG-PR-86L-PN5	EzS-NDR-86L-A	70VDC	1:5
Ezi-SERVO-PG-PR-86L-PN8	EzS-NDR-86L-A	70VDC	1:8
Ezi-SERVO-PG-PR-86L-PN10	EzS-NDR-86L-A	70VDC	1:10
Ezi-SERVO-PG-PR-86L-PN15	EzS-NDR-86L-A	70VDC	1:15
Ezi-SERVO-PG-PR-86L-PN25	EzS-NDR-86L-A	70VDC	1:25
Ezi-SERVO-PG-PR-86L-PN40	EzS-NDR-86L-A	70VDC	1:40
Ezi-SERVO-PG-PR-86L-PN50	EzS-NDR-86L-A	70VDC	1:50
Ezi-SERVO-PG-PR-86XL-PN3	EzS-NDR-86XL-A	70VDC	1:3
Ezi-SERVO-PG-PR-86XL-PN5	EzS-NDR-86XL-A	70VDC	1:5
Ezi-SERVO-PG-PR-86XL-PN8	EzS-NDR-86XL-A	70VDC	1:8
Ezi-SERVO-PG-PR-86XL-PN10	EzS-NDR-86XL-A	70VDC	1:10
Ezi-SERVO-PG-PR-86XL-PN15	EzS-NDR-86XL-A	70VDC	1:15
Ezi-SERVO-PG-PR-86XL-PN25	EzS-NDR-86XL-A	70VDC	1:25
Ezi-SERVO-PG-PR-86XL-PN40	EzS-NDR-86XL-A	70VDC	1:40
Ezi-SERVO-PG-PR-86XL-PN50	EzS-NDR-86XL-A	70VDC	1:50

بررسی، انتخاب و فرید آنلاین موتور

● Type of Ezi-SERVO PG Series

Now officially released for sale Ezi-SERVO PG Series are as follows.

◆ Ezi-SERVO BT Series

Ezi-SERVO BT Series			
Part Number	Combined Drive	Motor Voltage	Gear Ratio
Ezi-SERVO-PG-BT-42S-PN3	Built in Drive	24VDC	1:3
Ezi-SERVO-PG-BT-42S-PN5	Built in Drive	24VDC	1:5
Ezi-SERVO-PG-BT-42S-PN8	Built in Drive	24VDC	1:8
Ezi-SERVO-PG-BT-42S-PN10	Built in Drive	24VDC	1:10
Ezi-SERVO-PG-BT-42S-PN15	Built in Drive	24VDC	1:15
Ezi-SERVO-PG-BT-42S-PN25	Built in Drive	24VDC	1:25
Ezi-SERVO-PG-BT-42S-PN40	Built in Drive	24VDC	1:40
Ezi-SERVO-PG-BT-42S-PN50	Built in Drive	24VDC	1:50
Ezi-SERVO-PG-BT-42M-PN3	Built in Drive	24VDC	1:3
Ezi-SERVO-PG-BT-42M-PN5	Built in Drive	24VDC	1:5
Ezi-SERVO-PG-BT-42M-PN8	Built in Drive	24VDC	1:8
Ezi-SERVO-PG-BT-42M-PN10	Built in Drive	24VDC	1:10
Ezi-SERVO-PG-BT-42M-PN15	Built in Drive	24VDC	1:15
Ezi-SERVO-PG-BT-42M-PN25	Built in Drive	24VDC	1:25
Ezi-SERVO-PG-BT-42M-PN40	Built in Drive	24VDC	1:40
Ezi-SERVO-PG-BT-42M-PN50	Built in Drive	24VDC	1:50
Ezi-SERVO-PG-BT-42L-PN3	Built in Drive	24VDC	1:3
Ezi-SERVO-PG-BT-42L-PN5	Built in Drive	24VDC	1:5
Ezi-SERVO-PG-BT-42L-PN8	Built in Drive	24VDC	1:8
Ezi-SERVO-PG-BT-42L-PN10	Built in Drive	24VDC	1:10
Ezi-SERVO-PG-BT-42L-PN15	Built in Drive	24VDC	1:15
Ezi-SERVO-PG-BT-42L-PN25	Built in Drive	24VDC	1:25
Ezi-SERVO-PG-BT-42L-PN40	Built in Drive	24VDC	1:40
Ezi-SERVO-PG-BT-42L-PN50	Built in Drive	24VDC	1:50
Ezi-SERVO-PG-BT-42XL-PN3	Built in Drive	24VDC	1:3
Ezi-SERVO-PG-BT-42XL-PN5	Built in Drive	24VDC	1:5
Ezi-SERVO-PG-BT-42XL-PN8	Built in Drive	24VDC	1:8
Ezi-SERVO-PG-BT-42XL-PN10	Built in Drive	24VDC	1:10
Ezi-SERVO-PG-BT-42XL-PN15	Built in Drive	24VDC	1:15
Ezi-SERVO-PG-BT-42XL-PN25	Built in Drive	24VDC	1:25
Ezi-SERVO-PG-BT-42XL-PN40	Built in Drive	24VDC	1:40
Ezi-SERVO-PG-BT-42XL-PN50	Built in Drive	24VDC	1:50
Ezi-SERVO-PG-BT-56S-PN3	Built in Drive	24VDC	1:3
Ezi-SERVO-PG-BT-56S-PN5	Built in Drive	24VDC	1:5
Ezi-SERVO-PG-BT-56S-PN8	Built in Drive	24VDC	1:8
Ezi-SERVO-PG-BT-56S-PN10	Built in Drive	24VDC	1:10
Ezi-SERVO-PG-BT-56S-PN15	Built in Drive	24VDC	1:15
Ezi-SERVO-PG-BT-56S-PN25	Built in Drive	24VDC	1:25
Ezi-SERVO-PG-BT-56S-PN40	Built in Drive	24VDC	1:40
Ezi-SERVO-PG-BT-56S-PN50	Built in Drive	24VDC	1:50

Ezi-SERVO BT Series			
Part Number	Combined Drive	Motor Voltage	Gear Ratio
Ezi-SERVO-PG-BT-56M-PN3	Built in Drive	24VDC	1:3
Ezi-SERVO-PG-BT-56M-PN5	Built in Drive	24VDC	1:5
Ezi-SERVO-PG-BT-56M-PN8	Built in Drive	24VDC	1:8
Ezi-SERVO-PG-BT-56M-PN10	Built in Drive	24VDC	1:10
Ezi-SERVO-PG-BT-56M-PN15	Built in Drive	24VDC	1:15
Ezi-SERVO-PG-BT-56M-PN25	Built in Drive	24VDC	1:25
Ezi-SERVO-PG-BT-56M-PN40	Built in Drive	24VDC	1:40
Ezi-SERVO-PG-BT-56M-PN50	Built in Drive	24VDC	1:50
Ezi-SERVO-PG-BT-56L-PN3	Built in Drive	24VDC	1:3
Ezi-SERVO-PG-BT-56L-PN5	Built in Drive	24VDC	1:5
Ezi-SERVO-PG-BT-56L-PN8	Built in Drive	24VDC	1:8
Ezi-SERVO-PG-BT-56L-PN10	Built in Drive	24VDC	1:10
Ezi-SERVO-PG-BT-56L-PN15	Built in Drive	24VDC	1:15
Ezi-SERVO-PG-BT-56L-PN25	Built in Drive	24VDC	1:25
Ezi-SERVO-PG-BT-56L-PN40	Built in Drive	24VDC	1:40
Ezi-SERVO-PG-BT-56L-PN50	Built in Drive	24VDC	1:50
Ezi-SERVO-PG-BT-60S-PN3	Built in Drive	24VDC	1:3
Ezi-SERVO-PG-BT-60S-PN5	Built in Drive	24VDC	1:5
Ezi-SERVO-PG-BT-60S-PN8	Built in Drive	24VDC	1:8
Ezi-SERVO-PG-BT-60S-PN10	Built in Drive	24VDC	1:10
Ezi-SERVO-PG-BT-60S-PN15	Built in Drive	24VDC	1:15
Ezi-SERVO-PG-BT-60S-PN25	Built in Drive	24VDC	1:25
Ezi-SERVO-PG-BT-60S-PN40	Built in Drive	24VDC	1:40
Ezi-SERVO-PG-BT-60S-PN50	Built in Drive	24VDC	1:50
Ezi-SERVO-PG-BT-60M-PN3	Built in Drive	24VDC	1:3
Ezi-SERVO-PG-BT-60M-PN5	Built in Drive	24VDC	1:5
Ezi-SERVO-PG-BT-60M-PN8	Built in Drive	24VDC	1:8
Ezi-SERVO-PG-BT-60M-PN10	Built in Drive	24VDC	1:10
Ezi-SERVO-PG-BT-60M-PN15	Built in Drive	24VDC	1:15
Ezi-SERVO-PG-BT-60M-PN25	Built in Drive	24VDC	1:25
Ezi-SERVO-PG-BT-60M-PN40	Built in Drive	24VDC	1:40
Ezi-SERVO-PG-BT-60M-PN50	Built in Drive	24VDC	1:50
Ezi-SERVO-PG-BT-60L-PN3	Built in Drive	24VDC	1:3
Ezi-SERVO-PG-BT-60L-PN5	Built in Drive	24VDC	1:5
Ezi-SERVO-PG-BT-60L-PN8	Built in Drive	24VDC	1:8
Ezi-SERVO-PG-BT-60L-PN10	Built in Drive	24VDC	1:10
Ezi-SERVO-PG-BT-60L-PN15	Built in Drive	24VDC	1:15
Ezi-SERVO-PG-BT-60L-PN25	Built in Drive	24VDC	1:25
Ezi-SERVO-PG-BT-60L-PN40	Built in Drive	24VDC	1:40
Ezi-SERVO-PG-BT-60L-PN50	Built in Drive	24VDC	1:50

● Type of Ezi-SERVO PG Series

Now officially released for sale Ezi-SERVO PG Series are as follows.

◆ Ezi-SERVO ALL Series

Ezi-SERVO ALL Series			
Part Number	Combined Drive	Motor Voltage	Gear Ratio
Ezi-SERVO-PG-ALL-42S-PN3	Built in Drive	24VDC	1:3
Ezi-SERVO-PG-ALL-42S-PN5	Built in Drive	24VDC	1:5
Ezi-SERVO-PG-ALL-42S-PN8	Built in Drive	24VDC	1:8
Ezi-SERVO-PG-ALL-42S-PN10	Built in Drive	24VDC	1:10
Ezi-SERVO-PG-ALL-42S-PN15	Built in Drive	24VDC	1:15
Ezi-SERVO-PG-ALL-42S-PN25	Built in Drive	24VDC	1:25
Ezi-SERVO-PG-ALL-42S-PN40	Built in Drive	24VDC	1:40
Ezi-SERVO-PG-ALL-42S-PN50	Built in Drive	24VDC	1:50
Ezi-SERVO-PG-ALL-42M-PN3	Built in Drive	24VDC	1:3
Ezi-SERVO-PG-ALL-42M-PN5	Built in Drive	24VDC	1:5
Ezi-SERVO-PG-ALL-42M-PN8	Built in Drive	24VDC	1:8
Ezi-SERVO-PG-ALL-42M-PN10	Built in Drive	24VDC	1:10
Ezi-SERVO-PG-ALL-42M-PN15	Built in Drive	24VDC	1:15
Ezi-SERVO-PG-ALL-42M-PN25	Built in Drive	24VDC	1:25
Ezi-SERVO-PG-ALL-42M-PN40	Built in Drive	24VDC	1:40
Ezi-SERVO-PG-ALL-42M-PN50	Built in Drive	24VDC	1:50
Ezi-SERVO-PG-ALL-42L-PN3	Built in Drive	24VDC	1:3
Ezi-SERVO-PG-ALL-42L-PN5	Built in Drive	24VDC	1:5
Ezi-SERVO-PG-ALL-42L-PN8	Built in Drive	24VDC	1:8
Ezi-SERVO-PG-ALL-42L-PN10	Built in Drive	24VDC	1:10
Ezi-SERVO-PG-ALL-42L-PN15	Built in Drive	24VDC	1:15
Ezi-SERVO-PG-ALL-42L-PN25	Built in Drive	24VDC	1:25
Ezi-SERVO-PG-ALL-42L-PN40	Built in Drive	24VDC	1:40
Ezi-SERVO-PG-ALL-42L-PN50	Built in Drive	24VDC	1:50
Ezi-SERVO-PG-ALL-42XL-PN3	Built in Drive	24VDC	1:3
Ezi-SERVO-PG-ALL-42XL-PN5	Built in Drive	24VDC	1:5
Ezi-SERVO-PG-ALL-42XL-PN8	Built in Drive	24VDC	1:8
Ezi-SERVO-PG-ALL-42XL-PN10	Built in Drive	24VDC	1:10
Ezi-SERVO-PG-ALL-42XL-PN15	Built in Drive	24VDC	1:15
Ezi-SERVO-PG-ALL-42XL-PN25	Built in Drive	24VDC	1:25
Ezi-SERVO-PG-ALL-42XL-PN40	Built in Drive	24VDC	1:40
Ezi-SERVO-PG-ALL-42XL-PN50	Built in Drive	24VDC	1:50
Ezi-SERVO-PG-ALL-56S-PN3	Built in Drive	24VDC	1:3
Ezi-SERVO-PG-ALL-56S-PN5	Built in Drive	24VDC	1:5
Ezi-SERVO-PG-ALL-56S-PN8	Built in Drive	24VDC	1:8
Ezi-SERVO-PG-ALL-56S-PN10	Built in Drive	24VDC	1:10
Ezi-SERVO-PG-ALL-56S-PN15	Built in Drive	24VDC	1:15
Ezi-SERVO-PG-ALL-56S-PN25	Built in Drive	24VDC	1:25
Ezi-SERVO-PG-ALL-56S-PN40	Built in Drive	24VDC	1:40
Ezi-SERVO-PG-ALL-56S-PN50	Built in Drive	24VDC	1:50

Ezi-SERVO ALL Series			
Part Number	Combined Drive	Motor Voltage	Gear Ratio
Ezi-SERVO-PG-ALL-56M-PN3	Built in Drive	24VDC	1:3
Ezi-SERVO-PG-ALL-56M-PN5	Built in Drive	24VDC	1:5
Ezi-SERVO-PG-ALL-56M-PN8	Built in Drive	24VDC	1:8
Ezi-SERVO-PG-ALL-56M-PN10	Built in Drive	24VDC	1:10
Ezi-SERVO-PG-ALL-56M-PN15	Built in Drive	24VDC	1:15
Ezi-SERVO-PG-ALL-56M-PN25	Built in Drive	24VDC	1:25
Ezi-SERVO-PG-ALL-56M-PN40	Built in Drive	24VDC	1:40
Ezi-SERVO-PG-ALL-56M-PN50	Built in Drive	24VDC	1:50
Ezi-SERVO-PG-ALL-56L-PN3	Built in Drive	24VDC	1:3
Ezi-SERVO-PG-ALL-56L-PN5	Built in Drive	24VDC	1:5
Ezi-SERVO-PG-ALL-56L-PN8	Built in Drive	24VDC	1:8
Ezi-SERVO-PG-ALL-56L-PN10	Built in Drive	24VDC	1:10
Ezi-SERVO-PG-ALL-56L-PN15	Built in Drive	24VDC	1:15
Ezi-SERVO-PG-ALL-56L-PN25	Built in Drive	24VDC	1:25
Ezi-SERVO-PG-ALL-56L-PN40	Built in Drive	24VDC	1:40
Ezi-SERVO-PG-ALL-56L-PN50	Built in Drive	24VDC	1:50
Ezi-SERVO-PG-ALL-60S-PN3	Built in Drive	40VDC	1:3
Ezi-SERVO-PG-ALL-60S-PN5	Built in Drive	40VDC	1:5
Ezi-SERVO-PG-ALL-60S-PN8	Built in Drive	40VDC	1:8
Ezi-SERVO-PG-ALL-60S-PN10	Built in Drive	40VDC	1:10
Ezi-SERVO-PG-ALL-60S-PN15	Built in Drive	40VDC	1:15
Ezi-SERVO-PG-ALL-60S-PN25	Built in Drive	40VDC	1:25
Ezi-SERVO-PG-ALL-60S-PN40	Built in Drive	40VDC	1:40
Ezi-SERVO-PG-ALL-60S-PN50	Built in Drive	40VDC	1:50
Ezi-SERVO-PG-ALL-60M-PN3	Built in Drive	40VDC	1:3
Ezi-SERVO-PG-ALL-60M-PN5	Built in Drive	40VDC	1:5
Ezi-SERVO-PG-ALL-60M-PN8	Built in Drive	40VDC	1:8
Ezi-SERVO-PG-ALL-60M-PN10	Built in Drive	40VDC	1:10
Ezi-SERVO-PG-ALL-60M-PN15	Built in Drive	40VDC	1:15
Ezi-SERVO-PG-ALL-60M-PN25	Built in Drive	40VDC	1:25
Ezi-SERVO-PG-ALL-60M-PN40	Built in Drive	40VDC	1:40
Ezi-SERVO-PG-ALL-60M-PN50	Built in Drive	40VDC	1:50
Ezi-SERVO-PG-ALL-60L-PN3	Built in Drive	40VDC	1:3
Ezi-SERVO-PG-ALL-60L-PN5	Built in Drive	40VDC	1:5
Ezi-SERVO-PG-ALL-60L-PN8	Built in Drive	40VDC	1:8
Ezi-SERVO-PG-ALL-60L-PN10	Built in Drive	40VDC	1:10
Ezi-SERVO-PG-ALL-60L-PN15	Built in Drive	40VDC	1:15
Ezi-SERVO-PG-ALL-60L-PN25	Built in Drive	40VDC	1:25
Ezi-SERVO-PG-ALL-60L-PN40	Built in Drive	40VDC	1:40
Ezi-SERVO-PG-ALL-60L-PN50	Built in Drive	40VDC	1:50

● Ezi-SERVO PG Series Specifications and Outline Drawings

◆ Ezi-SERVO ST Series Specifications (Motor Size 42mm)

Part Number	Max. Holding Torque (N · m)	Rotor Inertia Moment (Kg · m ²)	Backlash (min)	Angular transmission error (min)	Gear ratio	Resolution (10,000ppr basis)	Allowable Torque (N · m)	Max. Torque (N · m)	Allowable speed range (rpm)	Weight of unit (Kg)				
Ezi-SERVO-PG-ST-42S-PN3 Ezi-SERVO-PG-MI-42S-PN3	0.8	35x10 ⁻⁷	3	5	3	0,012 °	6	18	0~1000	0,89				
Ezi-SERVO-PG-ST-42S-PN5 Ezi-SERVO-PG-MI-42S-PN5	1.4				5	0,0072 °	9	18	0~600					
Ezi-SERVO-PG-ST-42S-PN8 Ezi-SERVO-PG-MI-42S-PN8					8	0,0045 °	9	18	0~375					
Ezi-SERVO-PG-ST-42S-PN10 Ezi-SERVO-PG-MI-42S-PN10	2.7				10	0,0036 °	6	12	0~333					
Ezi-SERVO-PG-ST-42S-PN15 Ezi-SERVO-PG-MI-42S-PN15	4.0		5	7	15	0,0024 °	6	12	0~300	0,99				
Ezi-SERVO-PG-ST-42S-PN25 Ezi-SERVO-PG-MI-42S-PN25	6.6				25	0,00144 °	9	18	0~120					
Ezi-SERVO-PG-ST-42S-PN40 Ezi-SERVO-PG-MI-42S-PN40	9.0				40	0,0009 °	9	18	0~75					
Ezi-SERVO-PG-ST-42S-PN50 Ezi-SERVO-PG-MI-42S-PN50					50	0,00072 °	9	18	0~60					
Ezi-SERVO-PG-ST-42M-PN3 Ezi-SERVO-PG-MI-42M-PN3					1.1	54x10 ⁻⁷	3	5	3		0,012 °	6	18	0~1000
Ezi-SERVO-PG-ST-42M-PN5 Ezi-SERVO-PG-MI-42M-PN5	1.9				5				0,0072 °		9	18	0~600	
Ezi-SERVO-PG-ST-42M-PN8 Ezi-SERVO-PG-MI-42M-PN8		8	0,0045 °	9	18				0~375					
Ezi-SERVO-PG-ST-42M-PN10 Ezi-SERVO-PG-MI-42M-PN10	3.7	10	0,0036 °	6	12				0~333					
Ezi-SERVO-PG-ST-42M-PN15 Ezi-SERVO-PG-MI-42M-PN15	5.4	5	7	15	0,0024 °		6	12	0~300	1,06				
Ezi-SERVO-PG-ST-42M-PN25 Ezi-SERVO-PG-MI-42M-PN25	9.0			25	0,00144 °		9	18	0~120					
Ezi-SERVO-PG-ST-42M-PN40 Ezi-SERVO-PG-MI-42M-PN40				40	0,0009 °		9	18	0~75					
Ezi-SERVO-PG-ST-42M-PN50 Ezi-SERVO-PG-MI-42M-PN50				50	0,00072 °		9	18	0~60					
Ezi-SERVO-PG-ST-42L-PN3 Ezi-SERVO-PG-MI-42L-PN3	1.4			77x10 ⁻⁷	3		5	3	0,012 °		6	18	0~1000	1,02
Ezi-SERVO-PG-ST-42L-PN5 Ezi-SERVO-PG-MI-42L-PN5	2.4							5	0,0072 °		9	18	0~600	
Ezi-SERVO-PG-ST-42L-PN8 Ezi-SERVO-PG-MI-42L-PN8		3.8	8			0,0045 °		9	18	0~375				
Ezi-SERVO-PG-ST-42L-PN10 Ezi-SERVO-PG-MI-42L-PN10	4.7	10	0,0036 °			6		12	0~333					
Ezi-SERVO-PG-ST-42L-PN15 Ezi-SERVO-PG-MI-42L-PN15	6.0	5	7		15	0,0024 °	6	12	0~300	1,12				
Ezi-SERVO-PG-ST-42L-PN25 Ezi-SERVO-PG-MI-42L-PN25	9.0				25	0,00144 °	9	18	0~120					
Ezi-SERVO-PG-ST-42L-PN40 Ezi-SERVO-PG-MI-42L-PN40					40	0,0009 °	9	18	0~75					
Ezi-SERVO-PG-ST-42L-PN50 Ezi-SERVO-PG-MI-42L-PN50					50	0,00072 °	9	18	0~60					
Ezi-SERVO-PG-ST-42XL-PN3 Ezi-SERVO-PG-MI-42XL-PN3	1.8				114x10 ⁻⁷	3	5	3	0,012 °		6	18	0~1000	1,15
Ezi-SERVO-PG-ST-42XL-PN5 Ezi-SERVO-PG-MI-42XL-PN5	3.0							5	0,0072 °		9	18	0~600	
Ezi-SERVO-PG-ST-42XL-PN8 Ezi-SERVO-PG-MI-42XL-PN8		4.8	8	0,0045 °				9	18	0~375				
Ezi-SERVO-PG-ST-42XL-PN10 Ezi-SERVO-PG-MI-42XL-PN10	6.0	10	0,0036 °	6				12	0~333					
Ezi-SERVO-PG-ST-42XL-PN15 Ezi-SERVO-PG-MI-42XL-PN15	9.0	5	7	15		0,0024 °	6	12	0~300	1,25				
Ezi-SERVO-PG-ST-42XL-PN25 Ezi-SERVO-PG-MI-42XL-PN25				9.0		25	0,00144 °	9	18		0~120			
Ezi-SERVO-PG-ST-42XL-PN40 Ezi-SERVO-PG-MI-42XL-PN40						40	0,0009 °	9	18		0~75			
Ezi-SERVO-PG-ST-42XL-PN50 Ezi-SERVO-PG-MI-42XL-PN50	50					0,00072 °	9	18	0~60					

● Ezi-SERVO PG Series Specifications and Outline Drawings

◆ Ezi-SERVO ST & Plus-R Series Specifications (Motor Size 56mm)

Part Number	Max. Holding Torque (N · m)	Rotor Inertia Moment (Kg · m ²)	Backlash (min)	Angular transmission error (min)	Gear ratio	Resolution (10,000ppr basis)	Allowable Torque (N · m)	Max. Torque (N · m)	Allowable speed range (rpm)	Weight of unit (Kg)				
Ezi-SERVO-PG-PR-42S-PN3 Ezi-SERVO-PG-MI-PR-42S-PN3	0.8	35x10 ⁻⁷	3	5	3	0,012 °	6	18	0~1000	0,89				
Ezi-SERVO-PG-PR-42S-PN5 Ezi-SERVO-PG-MI-PR-42S-PN5	1.4				5	0,0072 °	9	18	0~600					
Ezi-SERVO-PG-PR-42S-PN8 Ezi-SERVO-PG-MI-PR-42S-PN8					8	0,0045 °	9	18	0~375					
Ezi-SERVO-PG-PR-42S-PN10 Ezi-SERVO-PG-MI-PR-42S-PN10	2.7				10	0,0036 °	6	12	0~333					
Ezi-SERVO-PG-PR-42S-PN15 Ezi-SERVO-PG-MI-PR-42S-PN15	4.0		5	7	15	0,0024 °	6	12	0~300	0,99				
Ezi-SERVO-PG-PR-42S-PN25 Ezi-SERVO-PG-MI-PR-42S-PN25	6.6				25	0,00144 °	9	18	0~120					
Ezi-SERVO-PG-PR-42S-PN40 Ezi-SERVO-PG-MI-PR-42S-PN40	9.0				40	0,0009 °	9	18	0~75					
Ezi-SERVO-PG-PR-42S-PN50 Ezi-SERVO-PG-MI-PR-42S-PN50					50	0,00072 °	9	18	0~60					
Ezi-SERVO-PG-PR-42M-PN3 Ezi-SERVO-PG-MI-PR-42M-PN3					1.1	54x10 ⁻⁷	3	5	3		0,012 °	6	18	0~1000
Ezi-SERVO-PG-PR-42M-PN5 Ezi-SERVO-PG-MI-PR-42M-PN5	1.9				5				0,0072 °		9	18	0~600	
Ezi-SERVO-PG-PR-42M-PN8 Ezi-SERVO-PG-MI-PR-42M-PN8		8	0,0045 °	9	18				0~375					
Ezi-SERVO-PG-PR-42M-PN10 Ezi-SERVO-PG-MI-PR-42M-PN10	3.7	10	0,0036 °	6	12				0~333					
Ezi-SERVO-PG-PR-42M-PN15 Ezi-SERVO-PG-MI-PR-42M-PN15	5.4	5	7	15	0,0024 °		6	12	0~300	1,06				
Ezi-SERVO-PG-PR-42M-PN25 Ezi-SERVO-PG-MI-PR-42M-PN25	9.0			25	0,00144 °		9	18	0~120					
Ezi-SERVO-PG-PR-42M-PN40 Ezi-SERVO-PG-MI-PR-42M-PN40				40	0,0009 °		9	18	0~75					
Ezi-SERVO-PG-PR-42M-PN50 Ezi-SERVO-PG-MI-PR-42M-PN50				50	0,00072 °		9	18	0~60					
Ezi-SERVO-PG-PR-42L-PN3 Ezi-SERVO-PG-MI-PR-42L-PN3	1.4			77x10 ⁻⁷	3		5	3	0,012 °		6	18	0~1000	1,02
Ezi-SERVO-PG-PR-42L-PN5 Ezi-SERVO-PG-MI-PR-42L-PN5	2.4							5	0,0072 °		9	18	0~600	
Ezi-SERVO-PG-PR-42L-PN8 Ezi-SERVO-PG-MI-PR-42L-PN8		3.8	8			0,0045 °		9	18	0~375				
Ezi-SERVO-PG-PR-42L-PN10 Ezi-SERVO-PG-MI-PR-42L-PN10	4.7	10	0,0036 °			6		12	0~333					
Ezi-SERVO-PG-PR-42L-PN15 Ezi-SERVO-PG-MI-PR-42L-PN15	6.0	5	7		15	0,0024 °	6	12	0~300	1,12				
Ezi-SERVO-PG-PR-42L-PN25 Ezi-SERVO-PG-MI-PR-42L-PN25	9.0				25	0,00144 °	9	18	0~120					
Ezi-SERVO-PG-PR-42L-PN40 Ezi-SERVO-PG-MI-PR-42L-PN40					40	0,0009 °	9	18	0~75					
Ezi-SERVO-PG-PR-42L-PN50 Ezi-SERVO-PG-MI-PR-42L-PN50					50	0,00072 °	9	18	0~60					
Ezi-SERVO-PG-PR-42XL-PN3 Ezi-SERVO-PG-MI-PR-42XL-PN3	1.8				114x10 ⁻⁷	3	5	3	0,012 °		6	18	0~1000	1,15
Ezi-SERVO-PG-PR-42XL-PN5 Ezi-SERVO-PG-MI-PR-42XL-PN5	3.0							5	0,0072 °		9	18	0~600	
Ezi-SERVO-PG-PR-42XL-PN8 Ezi-SERVO-PG-MI-PR-42XL-PN8		4.8	8	0,0045 °				9	18	0~375				
Ezi-SERVO-PG-PR-42XL-PN10 Ezi-SERVO-PG-MI-PR-42XL-PN10	6.0	10	0,0036 °	6				12	0~333					
Ezi-SERVO-PG-PR-42XL-PN15 Ezi-SERVO-PG-MI-PR-42XL-PN15	9.0	5	7	15		0,0024 °	6	12	0~300	1,25				
Ezi-SERVO-PG-PR-42XL-PN25 Ezi-SERVO-PG-MI-PR-42XL-PN25				25		0,00144 °	9	18	0~120					
Ezi-SERVO-PG-PR-42XL-PN40 Ezi-SERVO-PG-MI-PR-42XL-PN40				40		0,0009 °	9	18	0~75					
Ezi-SERVO-PG-PR-42XL-PN50 Ezi-SERVO-PG-MI-PR-42XL-PN50	50			0,00072 °		9	18	0~60						

● Ezi-SERVO PG Series Specifications and Outline Drawings

◆ Ezi-SERVO ST & Plus-R Series Specifications (Motor Size 56mm)

Part Number	Max. Holding Torque (N · m)	Rotor Inertia Moment (Kg · m ²)	Backlash (min)	Angular transmission error (min)	Gear ratio	Resolution (10,000ppr basis)	Allowable Torque (N · m)	Max. Torque (N · m)	Allowable speed range (rpm)	Weight of unit (Kg)			
Ezi-SERVO-PG-ST-56S-PN3 Ezi-SERVO-PG-PR-56S-PN3	1,6	120x10 ⁻⁷	3	5	3	0,012 °	27	50	0~1000	1,4			
Ezi-SERVO-PG-ST-56S-PN5 Ezi-SERVO-PG-PR-56S-PN5	2,7				5	0,0072 °	27	50	0~600	1,94			
Ezi-SERVO-PG-ST-56S-PN8 Ezi-SERVO-PG-PR-56S-PN8	4,3				8	0,0045 °	27	50	0~375				
Ezi-SERVO-PG-ST-56S-PN10 Ezi-SERVO-PG-PR-56S-PN10	5,3				10	0,0036 °	18	35	0~333				
Ezi-SERVO-PG-ST-56S-PN15 Ezi-SERVO-PG-PR-56S-PN15	7,7				15	0,0024 °	18	35	0~300	2,14			
Ezi-SERVO-PG-ST-56S-PN25 Ezi-SERVO-PG-PR-56S-PN25	12,9				25	0,00144 °	27	50	0~120				
Ezi-SERVO-PG-ST-56S-PN40 Ezi-SERVO-PG-PR-56S-PN40	20,6				40	0,0009 °	27	50	0~75				
Ezi-SERVO-PG-ST-56S-PN50 Ezi-SERVO-PG-PR-56S-PN50	25,8				50	0,00072 °	27	50	0~60				
Ezi-SERVO-PG-ST-56M-PN3 Ezi-SERVO-PG-PR-56M-PN3	2,6				200x10 ⁻⁷	3	5	3	0,0012 °	18	35	0~1000	1,4
Ezi-SERVO-PG-ST-56M-PN5 Ezi-SERVO-PG-PR-56M-PN5	4,4							5	0,0072 °	27	50	0~600	2,15
Ezi-SERVO-PG-ST-56M-PN8 Ezi-SERVO-PG-PR-56M-PN8	7,0	8	0,0045 °	27				50	0~375				
Ezi-SERVO-PG-ST-56M-PN10 Ezi-SERVO-PG-PR-56M-PN10	8,7	10	0,0036 °	18				35	0~333				
Ezi-SERVO-PG-ST-56M-PN15 Ezi-SERVO-PG-PR-56M-PN15	12,7	15	0,0024 °	18				35	0~300	2,35			
Ezi-SERVO-PG-ST-56M-PN25 Ezi-SERVO-PG-PR-56M-PN25	21,1	25	0,00144 °	27				50	0~120				
Ezi-SERVO-PG-ST-56M-PN40 Ezi-SERVO-PG-PR-56M-PN40	27,0	40	0,0009 °	27				50	0~75				
Ezi-SERVO-PG-ST-56M-PN50 Ezi-SERVO-PG-PR-56M-PN50		50	0,00072 °	27				50	0~60				
Ezi-SERVO-PG-ST-56L-PN3 Ezi-SERVO-PG-PR-56L-PN3	4,3	480x10 ⁻⁷	3	5				3	0,012 °	18	35	0~1000	1,4
Ezi-SERVO-PG-ST-56L-PN5 Ezi-SERVO-PG-PR-56L-PN5	7,2							5	0,0072 °	27	50	0~600	2,52
Ezi-SERVO-PG-ST-56L-PN8 Ezi-SERVO-PG-PR-56L-PN8	11,4				8	0,0045 °	27	50	0~375				
Ezi-SERVO-PG-ST-56L-PN10 Ezi-SERVO-PG-PR-56L-PN10	14,3				10	0,0036 °	18	35	0~333				
Ezi-SERVO-PG-ST-56L-PN15 Ezi-SERVO-PG-PR-56L-PN15	18,0				15	0,0024 °	18	35	0~300	2,72			
Ezi-SERVO-PG-ST-56L-PN25 Ezi-SERVO-PG-PR-56L-PN25	27,0				25	0,00144 °	27	50	0~120				
Ezi-SERVO-PG-ST-56L-PN40 Ezi-SERVO-PG-PR-56L-PN40					40	0,0009 °	27	50	0~75				
Ezi-SERVO-PG-ST-56L-PN50 Ezi-SERVO-PG-PR-56L-PN50					50	0,00072 °	27	50	0~60				

- * Possible to choose and set one of encoder resolution among 500, 1000, 1600, 2000, 3600, 5000, 6400, 7200, 10000
- * Allowable Torque is max. torque that can be added to gearbox output shaft during constant speed of operation
- * Max. Torque is max. torque that can be added to gearbox output shaft during Acceleration and deceleration of inertia load as like start and stop.
- * Allowable Torque and Max. Torque is only specifications from mechanical part of gearbox so please refer to speed-torque curve to check output torque of motor combined with gearbox.
- * During normal operation of constant speed, please drive less than Max. allowable torque except starts and stops because excess of permissible torque of gearbox can cause shortened life.
- * The direction of rotation of the motor and output shaft of gearbox is the same.

● Ezi-SERVO PG Series Specifications and Outline Drawings

◆ Ezi-SERVO ST & Plus-R Series Specifications (Motor Size 60mm)

Part Number	Max. Holding Torque (N · m)	Rotor Inertia Moment (Kg · m ²)	Backlash (min)	Angular transmission error (min)	Gear ratio	Resolution (10,000ppr basis)	Allowable Torque (N · m)	Max. Torque (N · m)	Allowable speed range (rpm)	Weight of unit (Kg)			
Ezi-SERVO-PG-ST-60S-PN3 Ezi-SERVO-PG-PR-60S-PN3	2,6	140x10 ⁻⁷	3	5	3	0,012 °	18	35	0~1000	1,4			
Ezi-SERVO-PG-ST-60S-PN5 Ezi-SERVO-PG-PR-60S-PN5	4,4				5	0,0072 °	27	50	0~600	2,0			
Ezi-SERVO-PG-ST-60S-PN8 Ezi-SERVO-PG-PR-60S-PN8	7,0				8	0,0045 °	27	50	0~375				
Ezi-SERVO-PG-ST-60S-PN10 Ezi-SERVO-PG-PR-60S-PN10	8,8				10	0,0036 °	18	35	0~333	2,2			
Ezi-SERVO-PG-ST-60S-PN15 Ezi-SERVO-PG-PR-60S-PN15	12,7				15	0,0024 °	18	35	0~300				
Ezi-SERVO-PG-ST-60S-PN25 Ezi-SERVO-PG-PR-60S-PN25	21,2				25	0,00144 °	27	50	0~120				
Ezi-SERVO-PG-ST-60S-PN40 Ezi-SERVO-PG-PR-60S-PN40	27,0				40	0,0009 °	27	50	0~75				
Ezi-SERVO-PG-ST-60S-PN50 Ezi-SERVO-PG-PR-60S-PN50					50	0,00072 °	27	50	0~60				
Ezi-SERVO-PG-ST-60M-PN3 Ezi-SERVO-PG-PR-60M-PN3	3,6				320x10 ⁻⁷	3	5	3	0,012 °	18	35	0~1000	1,4
Ezi-SERVO-PG-ST-60M-PN5 Ezi-SERVO-PG-PR-60M-PN5	6,0							5	0,0072 °	27	50	0~600	2,3
Ezi-SERVO-PG-ST-60M-PN8 Ezi-SERVO-PG-PR-60M-PN8	9,6	8	0,0045 °	27				50	0~375				
Ezi-SERVO-PG-ST-60M-PN10 Ezi-SERVO-PG-PR-60M-PN10	12,0	10	0,0036 °	18				35	0~333	2,5			
Ezi-SERVO-PG-ST-60M-PN15 Ezi-SERVO-PG-PR-60M-PN15	17,4	15	0,0024 °	18				35	0~300				
Ezi-SERVO-PG-ST-60M-PN25 Ezi-SERVO-PG-PR-60M-PN25	27,0	25	0,00144 °	27				50	0~120				
Ezi-SERVO-PG-ST-60M-PN40 Ezi-SERVO-PG-PR-60M-PN40		40	0,0009 °	27				50	0~75				
Ezi-SERVO-PG-ST-60M-PN50 Ezi-SERVO-PG-PR-60M-PN50		50	0,00072 °	27				50	0~60				
Ezi-SERVO-PG-ST-60L-PN3 Ezi-SERVO-PG-PR-60L-PN3	7,1	800x10 ⁻⁷	3	5				3	0,012 °	18	35	0~1000	1,4
Ezi-SERVO-PG-ST-60L-PN5 Ezi-SERVO-PG-PR-60L-PN5	11,9							5	0,0072 °	27	50	0~600	3,0
Ezi-SERVO-PG-ST-60L-PN8 Ezi-SERVO-PG-PR-60L-PN8	19,0				8	0,0045 °	27	50	0~375				
Ezi-SERVO-PG-ST-60L-PN10 Ezi-SERVO-PG-PR-60L-PN10	18,0				10	0,0036 °	18	35	0~333	3,2			
Ezi-SERVO-PG-ST-60L-PN15 Ezi-SERVO-PG-PR-60L-PN15					15	0,0024 °	18	35	0~300				
Ezi-SERVO-PG-ST-60L-PN25 Ezi-SERVO-PG-PR-56L-PN25	27,0				25	0,00144 °	27	50	0~120				
Ezi-SERVO-PG-ST-60L-PN40 Ezi-SERVO-PG-PR-60L-PN40					40	0,0009 °	27	50	0~75				
Ezi-SERVO-PG-ST-60L-PN50 Ezi-SERVO-PG-PR-60L-PN50					50	0,00072 °	27	50	0~60				

- * Possible to choose and set one of encoder resolution among 500, 1000, 1600, 2000, 3600, 5000, 6400, 7200, 10000
- * Allowable Torque is max. torque that can be added to gearbox output shaft during constant speed of operation
- * Max. Torque is max. torque that can be added to gearbox output shaft during Acceleration and deceleration of inertia load as like start and stop.
- * Allowable Torque and Max. Torque is only specifications from mechanical part of gearbox so please refer to speed-torque curve to check output torque of motor combined with gearbox.
- * During normal operation of constant speed, please drive less than Max. allowable torque except starts and stops because excess of permissible torque of gearbox can cause shortened life.
- * The direction of rotation of the motor and output shaft of gearbox is the same.

● Ezi-SERVO PG Series Specifications and Outline Drawings

◆ Ezi-SERVO ST & Plus-R Series Specifications (Motor Size 86mm)

Part Number	Max. Holding Torque (N · m)	Rotor Inertia Moment (Kg · m ²)	Backlash (min)	Angular transmission error (min)	Gear ratio	Resolution (10,000ppr basis)	Allowable Torque (N · m)	Max. Torque (N · m)	Allowable speed range (rpm)	Weight of unit (Kg)					
Ezi-SERVO-PG-ST-86M-PN3 Ezi-SERVO-PG-PR-86M-PN3	10,6	1400x10 ⁻⁷	3	5	3	0,012 °	50	80	0~1000	6,0					
Ezi-SERVO-PG-ST-86M-PN5 Ezi-SERVO-PG-PR-86M-PN5	17,7				5	0,0072 °	75	125	0~600						
Ezi-SERVO-PG-ST-86M-PN8 Ezi-SERVO-PG-PR-86M-PN8	28,3				8	0,0045 °	75	125	0~375						
Ezi-SERVO-PG-ST-86M-PN10 Ezi-SERVO-PG-PR-86M-PN10	35,4				10	0,0036 °	50	80	0~333						
Ezi-SERVO-PG-ST-86M-PN15 Ezi-SERVO-PG-PR-86M-PN15	50,0				15	0,0024 °	50	80	0~300						
Ezi-SERVO-PG-ST-86M-PN25 Ezi-SERVO-PG-PR-86M-PN25	75,0				25	0,00144 °	75	125	0~120	6,5					
Ezi-SERVO-PG-ST-86M-PN40 Ezi-SERVO-PG-PR-86M-PN40					40	0,0009 °	75	125	0~75						
Ezi-SERVO-PG-ST-86M-PN50 Ezi-SERVO-PG-PR-86M-PN50					50	0,00072 °	75	125	0~60						
Ezi-SERVO-PG-ST-86L-PN3 Ezi-SERVO-PG-PR-86L-PN3					20,5	2700x10 ⁻⁷	3	5	3		0,012 °	50	80	0~1000	7,5
Ezi-SERVO-PG-ST-86L-PN5 Ezi-SERVO-PG-PR-86L-PN5					34,1				5		0,0072 °	75	125	0~600	
Ezi-SERVO-PG-ST-86L-PN8 Ezi-SERVO-PG-PR-86L-PN8	54,5	8	0,0045 °	75	125				0~375						
Ezi-SERVO-PG-ST-86L-PN10 Ezi-SERVO-PG-PR-86L-PN10	50,0	10	0,0036 °	50	80				0~333						
Ezi-SERVO-PG-ST-86L-PN15 Ezi-SERVO-PG-PR-86L-PN15		15	0,0024 °	50	80				0~300						
Ezi-SERVO-PG-ST-86L-PN25 Ezi-SERVO-PG-PR-86L-PN25	75,0	25	0,00144 °	75	125				0~120	8,0					
Ezi-SERVO-PG-ST-86L-PN40 Ezi-SERVO-PG-PR-86L-PN40		40	0,0009 °	75	125				0~75						
Ezi-SERVO-PG-ST-86L-PN50 Ezi-SERVO-PG-PR-86L-PN50		50	0,00072 °	75	125				0~60						
Ezi-SERVO-PG-ST-86XL-PN3 Ezi-SERVO-PG-PR-86XL-PN3		24,7	4000x10 ⁻⁷	3	5				3		0,012 °	50	80	0~1000	9,0
Ezi-SERVO-PG-ST-86XL-PN5 Ezi-SERVO-PG-PR-86XL-PN5		41,1							5		0,0072 °	75	125	0~600	
Ezi-SERVO-PG-ST-86XL-PN8 Ezi-SERVO-PG-PR-86XL-PN8	65,8	8				0,0045 °	75	125	0~375						
Ezi-SERVO-PG-ST-86XL-PN10 Ezi-SERVO-PG-PR-86XL-PN10	50,0	10				0,0036 °	50	80	0~333						
Ezi-SERVO-PG-ST-86XL-PN15 Ezi-SERVO-PG-PR-86XL-PN15		15				0,0024 °	50	80	0~300						
Ezi-SERVO-PG-ST-86XL-PN25 Ezi-SERVO-PG-PR-86XL-PN25	75,0	25				0,00144 °	75	125	0~120	9,5					
Ezi-SERVO-PG-ST-86XL-PN40 Ezi-SERVO-PG-PR-86XL-PN40		40				0,0009 °	75	125	0~75						
Ezi-SERVO-PG-ST-86XL-PN50 Ezi-SERVO-PG-PR-86XL-PN50		50				0,00072 °	75	125	0~60						

- * Possible to choose and set one of encoder resolution among 500, 1000, 1600, 2000, 3600, 5000, 6400, 7200, 10000
- * Allowable Torque is max. torque that can be added to gearbox output shaft during constant speed of operation
- * Max. Torque is max. torque that can be added to gearbox output shaft during Acceleration and deceleration of inertia load as like start and stop.
- * Allowable Torque and Max. Torque is only specifications from mechanical part of gearbox so please refer to speed-torque curve to check output torque of motor combined with gearbox.
- * During normal operation of constant speed, please drive less than Max. allowable torque except starts and stops because excess of permissible torque of gearbox can cause shortened life.
- * The direction of rotation of the motor and output shaft of gearbox is the same.

Ezi-SERVO PG Series Specifications and Outline Drawings

◆ Ezi-SERVO ST & Plus-R Series Drawing (Motor Size 42mm)

Part Name	Part name of applied motor	Gear stage	□ Gear Ratio	Length (mm)
Ezi-SERVO-PG-ST-42S-PN □ Ezi-SERVO-PG-MI-42S-PN □ Ezi-SERVO-PG-PR-56S-PN □ Ezi-SERVO-PG-MI-PR-42S-PN □	EzM-42S	Single	3, 5, 8, 10	33
Ezi-SERVO-PG-ST-42M-PN □ Ezi-SERVO-PG-MI-42M-PN □ Ezi-SERVO-PG-PR-56M-PN □ Ezi-SERVO-PG-MI-PR-42M-PN □	EzM-42M			
Ezi-SERVO-PG-ST-42L-PN □ Ezi-SERVO-PG-MI-42L-PN □ Ezi-SERVO-PG-PR-56L-PN □ Ezi-SERVO-PG-MI-PR-42L-PN □	EzM-42L			
Ezi-SERVO-PG-ST-42XL-PN □ Ezi-SERVO-PG-MI-42XL-PN □ Ezi-SERVO-PG-PR-56XL-PN □ Ezi-SERVO-PG-MI-PR-42XL-PN □	EzM-42XL			

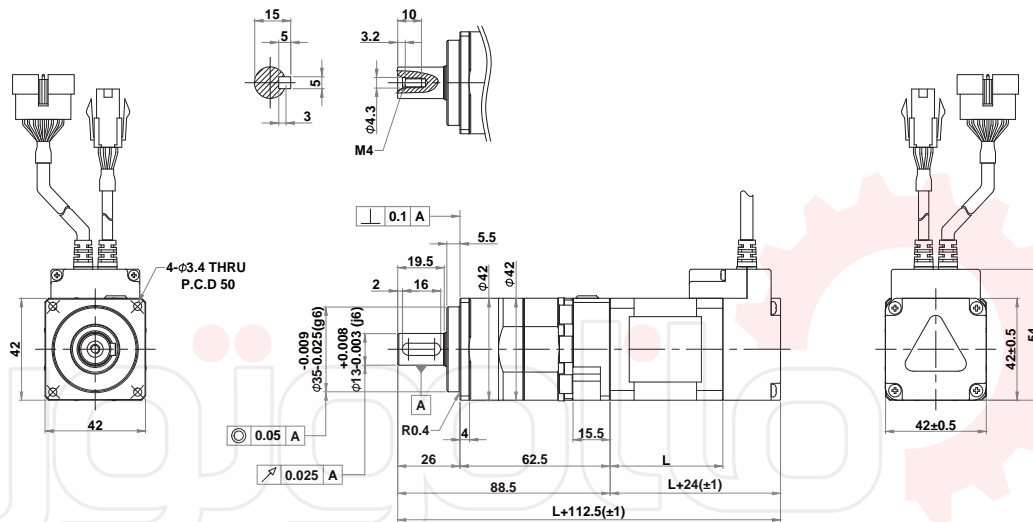

Part Name	Part name of applied motor	Gear stage	□ Gear Ratio	Length (mm)
Ezi-SERVO-PG-ST-42S-PN □ Ezi-SERVO-PG-MI-42S-PN □ Ezi-SERVO-PG-PR-56S-PN □ Ezi-SERVO-PG-MI-PR-42S-PN □	EzM-42S	Double	15, 25, 40, 50	33
Ezi-SERVO-PG-ST-42M-PN □ Ezi-SERVO-PG-MI-42M-PN □ Ezi-SERVO-PG-PR-56M-PN □ Ezi-SERVO-PG-MI-PR-42M-PN □	EzM-42M			
Ezi-SERVO-PG-ST-42L-PN □ Ezi-SERVO-PG-MI-42L-PN □ Ezi-SERVO-PG-PR-56L-PN □ Ezi-SERVO-PG-MI-PR-42L-PN □	EzM-42L			
Ezi-SERVO-PG-ST-42XL-PN □ Ezi-SERVO-PG-MI-42XL-PN □ Ezi-SERVO-PG-PR-56XL-PN □ Ezi-SERVO-PG-MI-PR-42XL-PN □	EzM-42XL			

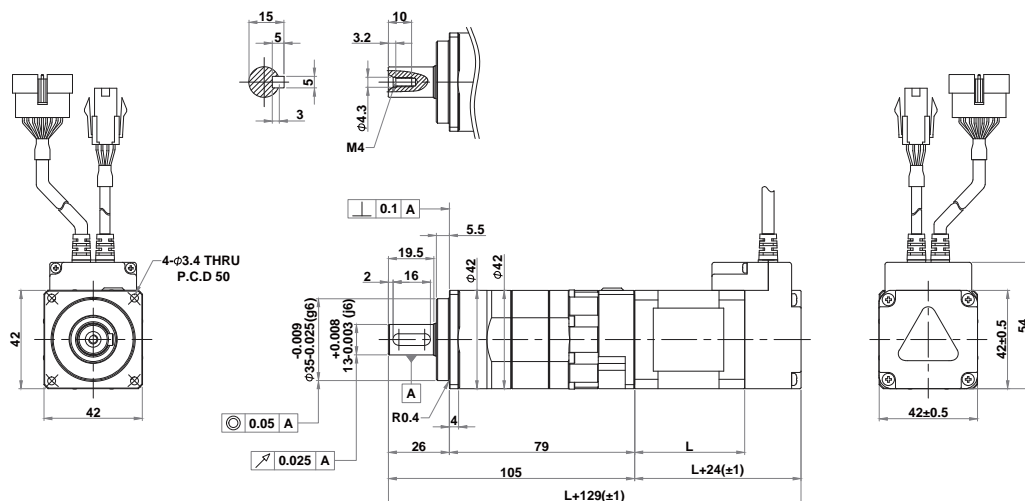

● Ezi-SERVO PG Series Specifications and Outline Drawings

◆ Ezi-SERVO ST & Plus-R Series Drawing (Motor Size 56mm)

Part Name	Part Name of Applied Motor	Gear Stage	□ Gear Ratio	Length (mm)
Ezi-SERVO-PG-ST-56S-PN□ Ezi-SERVO-PG-PR-56S-PN□	EzM-56S	Single	3, 5, 8, 10	46
Ezi-SERVO-PG-ST-56M-PN□ Ezi-SERVO-PG-PR-56M-PN□	EzM-56M		3, 5, 8, 10	54
Ezi-SERVO-PG-ST-56L-PN□ Ezi-SERVO-PG-PR-56L-PN□	EzM-56L		3, 5, 8, 10	80

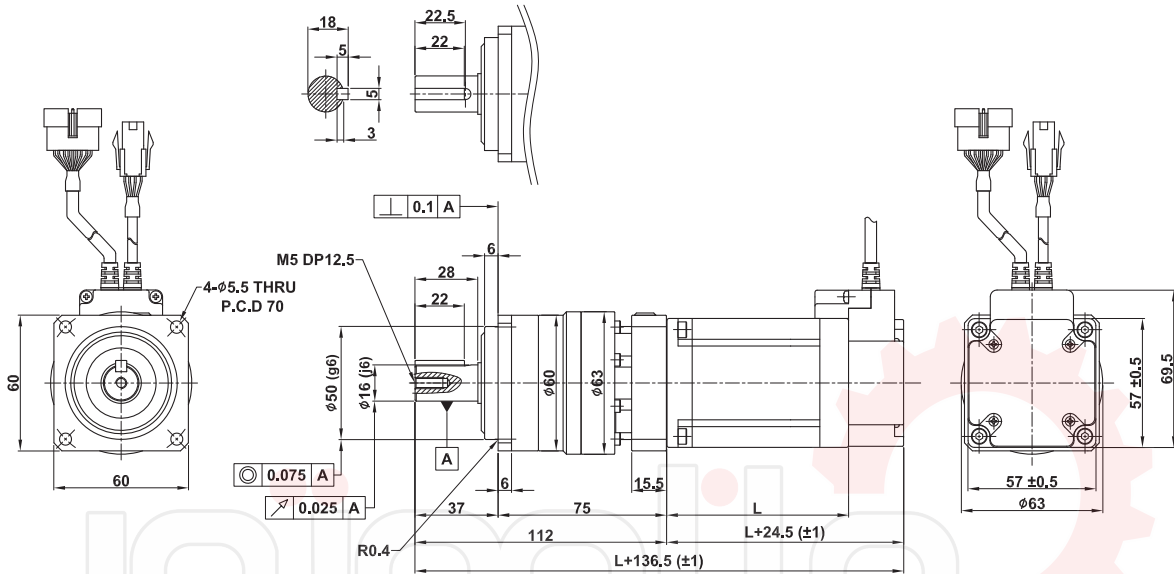

Part Name	Part Name of Applied Motor	Gear Stage	□ Gear Ratio	Length (mm)
Ezi-SERVO-PG-ST-56S-PN□ Ezi-SERVO-PG-PR-56S-PN□	EzM-56S	Double	15, 25, 40, 50	46
Ezi-SERVO-PG-ST-56M-PN□ Ezi-SERVO-PG-PR-56M-PN□	EzM-56M		15, 25, 40, 50	54
Ezi-SERVO-PG-ST-56L-PN□ Ezi-SERVO-PG-PR-56L-PN□	EzM-56L		15, 25, 40, 50	80

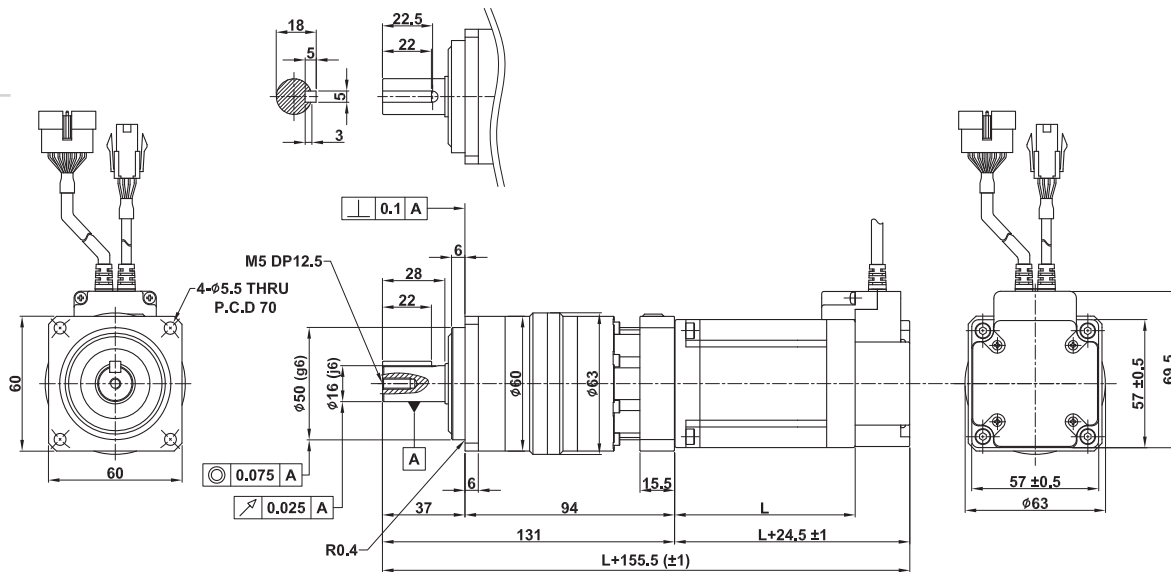

FASTECH Ezi-SERVO PG

● Ezi-SERVO PG Series Specifications and Outline Drawings

◆ Ezi-SERVO ST & Plus-R Series Drawing (Motor Size 60mm)

Part Name	Part Name of Applied Motor	Gear Stage	□ Gear Ratio	Length (mm)
Ezi-SERVO-PG-ST-60S-PN□ Ezi-SERVO-PG-PR-60S-PN□	EzM-60S	Single	3, 5, 8, 10	46
Ezi-SERVO-PG-ST-60M-PN□ Ezi-SERVO-PG-PR-60M-PN□	EzM-60M		3, 5, 8, 10	56
Ezi-SERVO-PG-ST-60L-PN□ Ezi-SERVO-PG-PR-60L-PN□	EzM-60L		3, 5, 8, 10	90

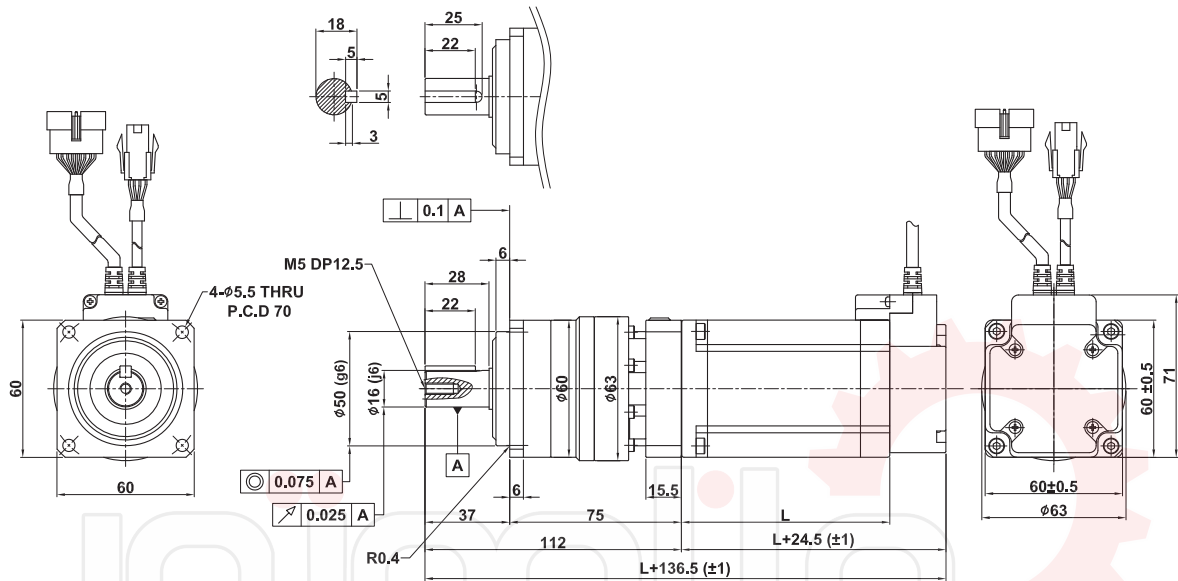

Part Name	Part Name of Applied Motor	Gear Stage	□ Gear Ratio	Length (mm)
Ezi-SERVO-PG-ST-60S-PN□ Ezi-SERVO-PG-PR-60S-PN□	EzM-60S	Double	15, 25, 40, 50	46
Ezi-SERVO-PG-ST-60M-PN□ Ezi-SERVO-PG-PR-60M-PN□	EzM-60M		15, 25, 40, 50	56
Ezi-SERVO-PG-ST-60L-PN□ Ezi-SERVO-PG-PR-60L-PN□	EzM-60L		15, 25, 40, 50	90

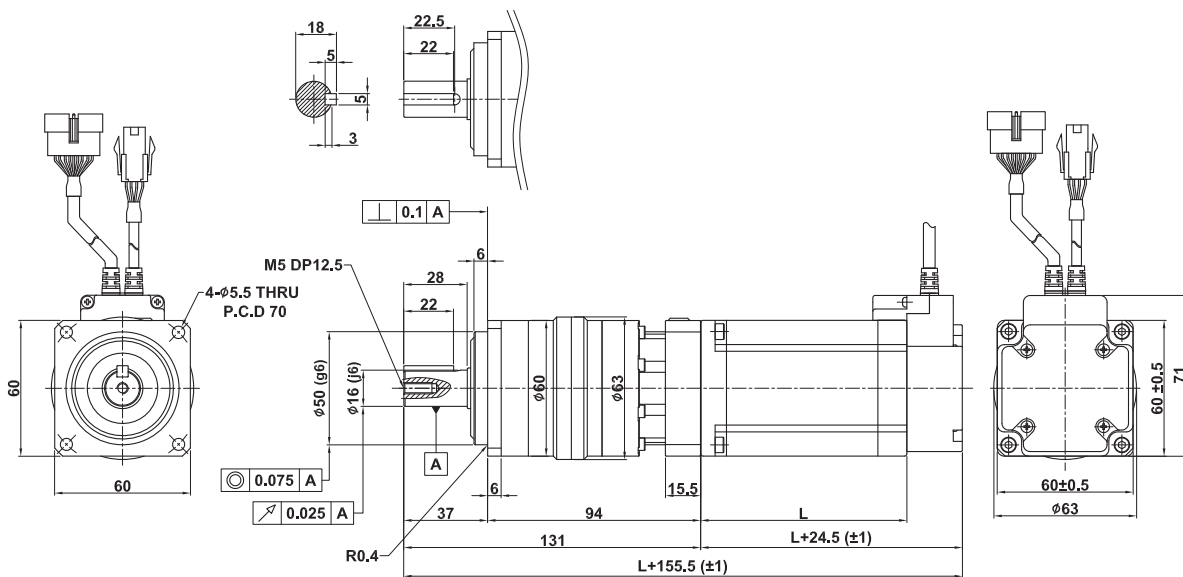

● Ezi-SERVO PG Series Specifications and Outline Drawings

◆ Ezi-SERVO ST & Plus-R Series Drawing (Motor Size 86mm)

Part Name	Part Name of Applied Motor	Gear Stage	□ Gear Ratio	Length (mm)
Ezi-SERVO-PG-ST-86M-PN□ Ezi-SERVO-PG-PR-86M-PN□	EzM-86M	Single	3, 5, 8, 10	79
Ezi-SERVO-PG-ST-86L-PN□ Ezi-SERVO-PG-PR-86L-PN□	EzM-86L		3, 5, 8, 10	117
Ezi-SERVO-PG-ST-86XL-PN□ Ezi-SERVO-PG-PR-86XL-PN□	EzM-86XL		3, 5, 8, 10	155

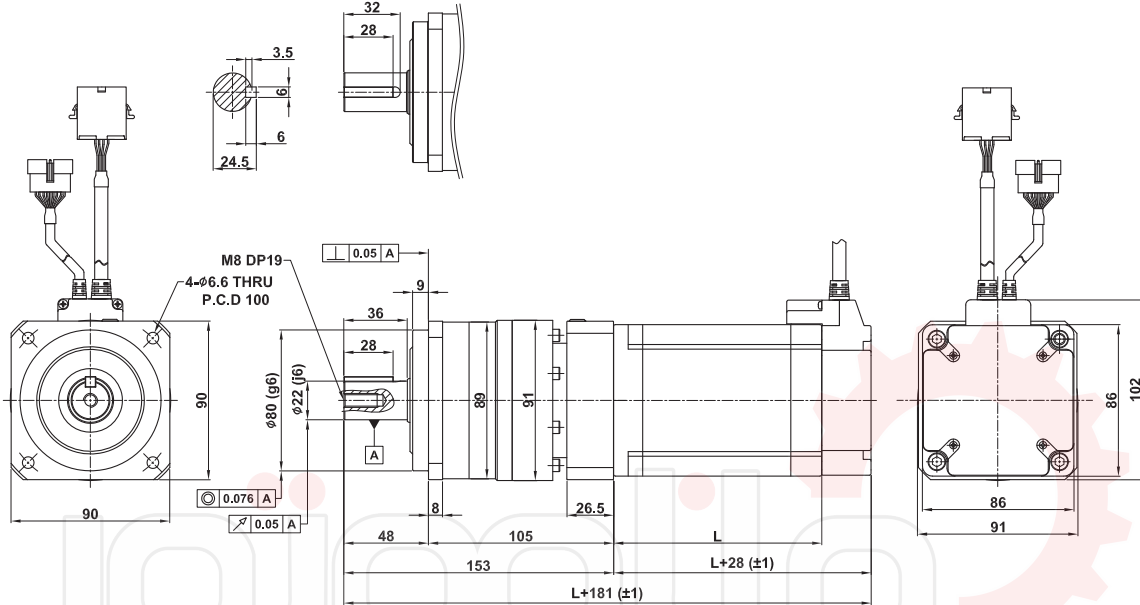

Part Name	Part Name of Applied Motor	Gear Stage	□ Gear Ratio	Length (mm)
Ezi-SERVO-PG-ST-86M-PN□ Ezi-SERVO-PG-PR-86M-PN□	EzM-86M	Double	15, 25, 40, 50	79
Ezi-SERVO-PG-ST-86L-PN□ Ezi-SERVO-PG-PR-86L-PN□	EzM-86L		15, 25, 40, 50	117
Ezi-SERVO-PG-ST-86XL-PN□ Ezi-SERVO-PG-PR-86XL-PN□	EzM-86XL		15, 25, 40, 50	155

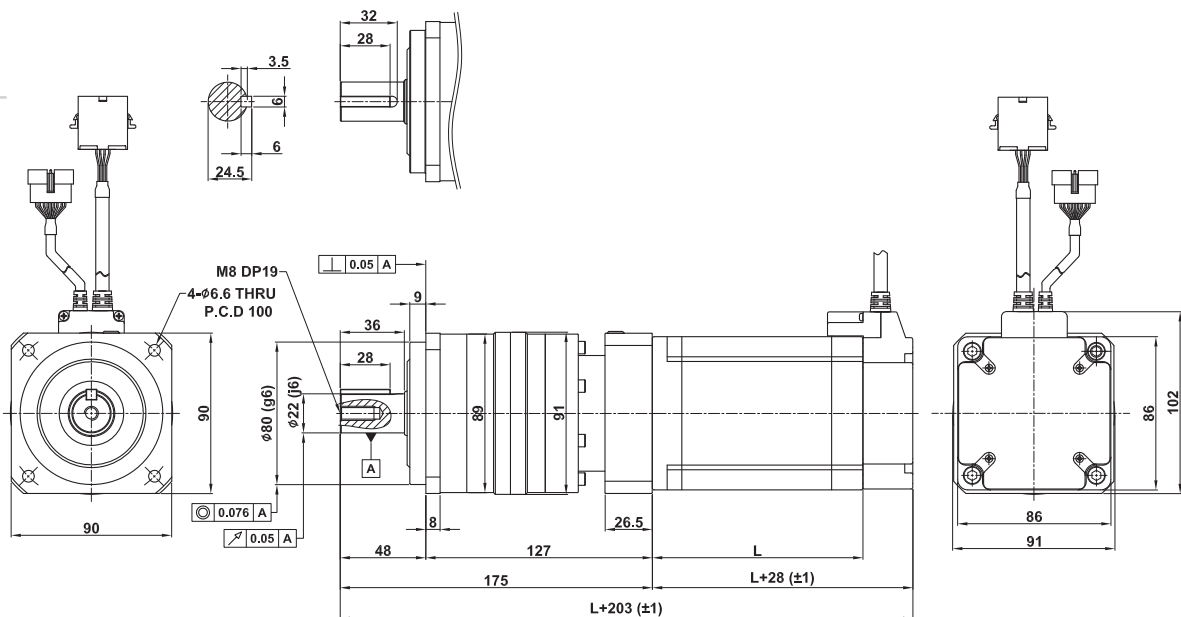

● Ezi-SERVO PG Series Specifications and Outline Drawings

◆ Ezi-SERVO BT Series Specifications (Motor Size 42mm)

Part Number	Max. Holding Torque (N · m)	Rotor Inertia Moment (Kg · m ²)	Backlash (min)	Angular transmission error (min)	Gear ratio	Resolution (10,000ppr basis)	Allowable Torque (N · m)	Max. Torque (N · m)	Allowable speed range (rpm)	Weight of unit (Kg)					
Ezi-SERVO-PG-BT-42S-PN3	0,8	35x10 ⁻⁷	3	5	3	0,012 °	6	18	0~1000	0,97					
Ezi-SERVO-PG-BT-42S-PN5	1,4				5	0,0072 °	9	18	0~600						
Ezi-SERVO-PG-BT-42S-PN8	2,2				8	0,0045 °	9	18	0~375						
Ezi-SERVO-PG-BT-42S-PN10	2,7				10	0,0036 °	6	12	0~333						
Ezi-SERVO-PG-BT-42S-PN15	4,0		5	7	15	0,0024 °	6	12	0~300	1,07					
Ezi-SERVO-PG-BT-42S-PN25	6,6				25	0,00144 °	9	18	0~120						
Ezi-SERVO-PG-BT-42S-PN40	9,0				40	0,0009 °	9	18	0~75						
Ezi-SERVO-PG-BT-42S-PN50					50	0,00072 °	9	18	0~60						
Ezi-SERVO-PG-BT-42M-PN3					1,1	54x10 ⁻⁷	3	5	3		0,012 °	6	18	0~1000	1,04
Ezi-SERVO-PG-BT-42M-PN5					1,9				5		0,0072 °	9	18	0~600	
Ezi-SERVO-PG-BT-42M-PN8	3,0	8	0,0045 °	9	18				0~375						
Ezi-SERVO-PG-BT-42M-PN10	3,7	10	0,0036 °	6	12				0~333						
Ezi-SERVO-PG-BT-42M-PN15	5,4	5	7	15	0,0024 °		6	12	0~300	1,14					
Ezi-SERVO-PG-BT-42M-PN25	9,0			25	0,00144 °		9	18	0~120						
Ezi-SERVO-PG-BT-42M-PN40				40	0,0009 °		9	18	0~75						
Ezi-SERVO-PG-BT-42M-PN50				50	0,00072 °		9	18	0~60						
Ezi-SERVO-PG-BT-42L-PN3				1,4	77x10 ⁻⁷		3	5	3		0,012 °	6	18	0~1000	1,10
Ezi-SERVO-PG-BT-42L-PN5	2,4			5					0,0072 °		9	18	0~600		
Ezi-SERVO-PG-BT-42L-PN8	3,8	8	0,0045 °	9		18			0~375						
Ezi-SERVO-PG-BT-42L-PN10	4,7	10	0,0036 °	6		12			0~333						
Ezi-SERVO-PG-BT-42L-PN15	6,0	5	7	15		0,0024 °	6	12	0~300	1,20					
Ezi-SERVO-PG-BT-42L-PN25	9,0			25		0,00144 °	9	18	0~120						
Ezi-SERVO-PG-BT-42L-PN40				40		0,0009 °	9	18	0~75						
Ezi-SERVO-PG-BT-42L-PN50				50		0,00072 °	9	18	0~60						
Ezi-SERVO-PG-BT-42XL-PN3				1,8		114x10 ⁻⁷	3	5	3		0,012 °	6	18	0~1000	1,15
Ezi-SERVO-PG-BT-42XL-PN5	3,0			5					0,0072 °		9	18	0~600		
Ezi-SERVO-PG-BT-42XL-PN8	4,8	8	0,0045 °	9	18				0~375						
Ezi-SERVO-PG-BT-42XL-PN10	6,0	10	0,0036 °	6	12				0~333						
Ezi-SERVO-PG-BT-42XL-PN15		9,0	15	0,0024 °	6		12	0~300	0,25						
Ezi-SERVO-PG-BT-42XL-PN25			5	7	25		0,00144 °	9		18	0~120				
Ezi-SERVO-PG-BT-42XL-PN40					40		0,0009 °	9		18	0~75				
Ezi-SERVO-PG-BT-42XL-PN50					50		0,00072 °	9		18	0~60				

* Possible to choose and set one of encoder resolution among 500, 1000, 1600, 2000, 3600, 5000, 6400, 7200, 10000

* Allowable Torque is max. torque that can be added to gearbox output shaft during constant speed of operation

* Max. Torque is max. torque that can be added to gearbox output shaft during Acceleration and deceleration of inertia load as like start and stop.

* Allowable Torque and Max. Torque is only specifications from mechanical part of gearbox so please refer to speed-torque curve to check output torque of motor combined with gearbox.

* During normal operation of constant speed, please drive less than Max. allowable torque except starts and stops because excess of permissible torque of gearbox can cause shortened life.

* The direction of rotation of the motor and output shaft of gearbox is the same.

● Ezi-SERVO PG Series Specifications and Outline Drawings

◆ Ezi-SERVO BT Series Drawing (Motor Size 56mm)

Part Number	Max. Holding Torque (N · m)	Rotor Inertia Moment (Kg · m ²)	Backlash (min)	Angular transmission error (min)	Gear ratio	Resolution (10,000ppr basis)	Allowable Torque (N · m)	Max. Torque (N · m)	Allowable speed range (rpm)	Weight of unit (Kg)
Ezi-SERVO-PG-BT-56S-PN3	1,6	120x10 ⁻⁷	3	5	3	0,012 °	18	35	0~1000	1,9
Ezi-SERVO-PG-BT-56S-PN5	2,7				5	0,0072 °	27	50	0~600	
Ezi-SERVO-PG-BT-56S-PN8	4,3				8	0,0045 °	27	50	0~375	
Ezi-SERVO-PG-BT-56S-PN10	5,3				10	0,0036 °	18	35	0~333	
Ezi-SERVO-PG-BT-56S-PN15	7,7				15	0,0024 °	18	35	0~300	2,1
Ezi-SERVO-PG-BT-56S-PN25	12,9				25	0,00144 °	27	50	0~120	
Ezi-SERVO-PG-BT-56S-PN40	20,6				40	0,0009 °	27	50	0~75	
Ezi-SERVO-PG-BT-56S-PN50	25,8				50	0,00072 °	27	50	0~60	
Ezi-SERVO-PG-BT-56M-PN3	2,6	200x10 ⁻⁷	3	5	3	0,012 °	18	35	0~1000	2,1
Ezi-SERVO-PG-BT-56M-PN5	4,4				5	0,0072 °	27	50	0~600	
Ezi-SERVO-PG-BT-56M-PN8	7,0				8	0,0045 °	27	50	0~375	
Ezi-SERVO-PG-BT-56M-PN10	8,7				10	0,0036 °	18	35	0~333	
Ezi-SERVO-PG-BT-56M-PN15	12,7				15	0,0024 °	18	35	0~300	2,3
Ezi-SERVO-PG-BT-56M-PN25	21,1				25	0,00144 °	27	50	0~120	
Ezi-SERVO-PG-BT-56M-PN40	27,0				40	0,0009 °	27	50	0~75	
Ezi-SERVO-PG-BT-56M-PN50					50	0,00072 °	27	50	0~60	
Ezi-SERVO-PG-BT-56L-PN3	4,3	480x10 ⁻⁷	3	5	3	0,012 °	18	35	0~1000	2,55
Ezi-SERVO-PG-BT-56L-PN5	7,2				5	0,0072 °	27	50	0~600	
Ezi-SERVO-PG-BT-56L-PN8	11,4				8	0,0045 °	27	50	0~375	
Ezi-SERVO-PG-BT-56L-PN10	14,3				10	0,0036 °	18	35	0~333	
Ezi-SERVO-PG-BT-56L-PN15	18,0				15	0,0024 °	18	35	0~300	2,75
Ezi-SERVO-PG-BT-56L-PN25	27,0				25	0,00144 °	27	50	0~120	
Ezi-SERVO-PG-BT-56L-PN40					40	0,0009 °	27	50	0~75	
Ezi-SERVO-PG-BT-56L-PN50					50	0,00072 °	27	50	0~60	

* Possible to choose and set one of encoder resolution among 500, 1000, 1600, 2000, 3600, 5000, 6400, 7200, 10000

* Allowable Torque is max. torque that can be added to gearbox output shaft during constant speed of operation

* Max. Torque is max. torque that can be added to gearbox output shaft during Acceleration and deceleration of inertia load as like start and stop.

* Allowable Torque and Max. Torque is only specifications from mechanical part of gearbox so please refer to speed-torque curve to check output torque of motor combined with gearbox.

* During normal operation of constant speed, please drive less than Max. allowable torque except starts and stops because excess of permissible torque of gearbox can cause shortened life.

* The direction of rotation of the motor and output shaft of gearbox is the same.

● Ezi-SERVO PG Series Specifications and Outline Drawings

◆ Ezi-SERVO BT Series Specifications (Motor Size 60mm)

Part Number	Max. Holding Torque (N · m)	Rotor Inertia Moment (Kg · m ²)	Backlash (min)	Angular transmission error (min)	Gear ratio	Resolution (10,000ppr basis)	Allowable Torque (N · m)	Max. Torque (N · m)	Allowable speed range (rpm)	Weight of unit (Kg)
Ezi-SERVO-PG-BT-60S-PN3	2,6	140x10 ⁻⁷	3	5	3	0,012 °	18	35	0~1000	2
Ezi-SERVO-PG-BT-60S-PN5	4,4				5	0,0072 °	27	50	0~600	
Ezi-SERVO-PG-BT-60S-PN8	7,0				8	0,0045 °	27	50	0~375	
Ezi-SERVO-PG-BT-60S-PN10	8,8				10	0,0036 °	18	35	0~333	
Ezi-SERVO-PG-BT-60S-PN15	12,7				15	0,0024 °	18	35	0~300	2,2
Ezi-SERVO-PG-BT-60S-PN25	21,2				25	0,00144 °	27	50	0~120	
Ezi-SERVO-PG-BT-60S-PN40	27,0				40	0,0009 °	27	50	0~75	
Ezi-SERVO-PG-BT-60S-PN50					50	0,00072 °	27	50	0~60	
Ezi-SERVO-PG-BT-60M-PN3	3,6	320x10 ⁻⁷	3	5	3	0,012 °	18	35	0~1000	2,3
Ezi-SERVO-PG-BT-60M-PN5	6,0				5	0,0072 °	27	50	0~600	
Ezi-SERVO-PG-BT-60M-PN8	9,6				8	0,0045 °	27	50	0~375	
Ezi-SERVO-PG-BT-60M-PN10	12,0				10	0,0036 °	18	35	0~333	
Ezi-SERVO-PG-BT-60M-PN15	17,4				15	0,0024 °	18	35	0~300	2,5
Ezi-SERVO-PG-BT-60M-PN25	27,0				25	0,00144 °	27	50	0~120	
Ezi-SERVO-PG-BT-60M-PN40					40	0,0009 °	27	50	0~75	
Ezi-SERVO-PG-BT-60M-PN50					50	0,00072 °	27	50	0~60	
Ezi-SERVO-PG-BT-60L-PN3		7,1	800x10 ⁻⁷	3	5	3	0,012 °	18	35	0~1000
Ezi-SERVO-PG-BT-60L-PN5	11,9	5				0,0072 °	27	50	0~600	
Ezi-SERVO-PG-BT-60L-PN8	19,0	8				0,0045 °	27	50	0~375	
Ezi-SERVO-PG-BT-60L-PN10	18,0	10				0,0036 °	18	35	0~333	
Ezi-SERVO-PG-BT-60L-PN15		15				0,0024 °	18	35	0~300	3,2
Ezi-SERVO-PG-BT-60L-PN25		25				0,00144 °	27	50	0~120	
Ezi-SERVO-PG-BT-60L-PN40		27,0				40	0,0009 °	27	50	
Ezi-SERVO-PG-BT-60L-PN50	50					0,00072 °	27	50	0~60	

* Possible to choose and set one of encoder resolution among 500, 1000, 1600, 2000, 3600, 5000, 6400, 7200, 10000

* Allowable Torque is max. torque that can be added to gearbox output shaft during constant speed of operation

* Max. Torque is max. torque that can be added to gearbox output shaft during Acceleration and deceleration of inertia load as like start and stop.

* Allowable Torque and Max. Torque is only specifications from mechanical part of gearbox so please refer to speed-torque curve to check output torque of motor combined with gearbox.

* During normal operation of constant speed, please drive less than Max. allowable torque except starts and stops because excess of permissible torque of gearbox can cause shortened life.

* The direction of rotation of the motor and output shaft of gearbox is the same.

Ezi-SERVO PG Series Specifications and Outline Drawings

◆ Ezi-SERVO BT Series Drawing (Motor Size 42mm)

Part Name	Part Name of Applied Motor	Gear Stage	□ Gear Ratio	Length (mm)
Ezi-SERVO-PG-BT-42S-PN□	EzM-42S	Single	3, 5, 8, 10	33
Ezi-SERVO-PG-BT-42M-PN□	EzM-42M		3, 5, 8, 10	39
Ezi-SERVO-PG-BT-42L-PN□	EzM-42L		3, 5, 8, 10	47
Ezi-SERVO-PG-BT-42XL-PN□	EzM-42XL		3, 5, 8, 10	59

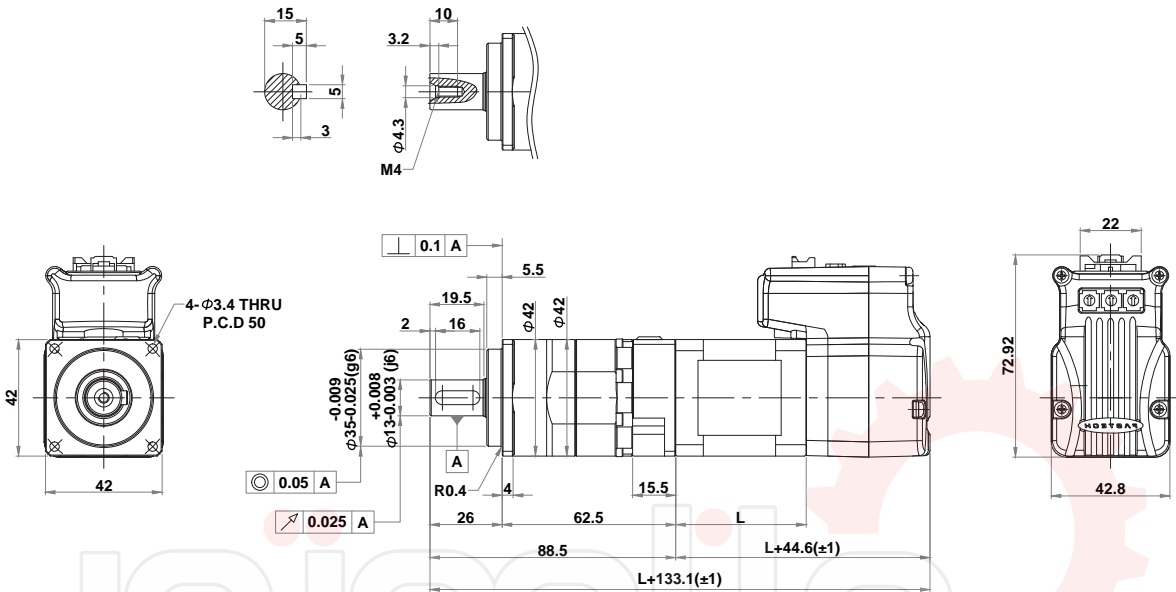

Part Name	Part Name of Applied Motor	Gear Stage	□ Gear Ratio	Length (mm)
Ezi-SERVO-PG-BT-42S-PN□	EzM-42S	Double	15, 25, 40, 50	33
Ezi-SERVO-PG-BT-42M-PN□	EzM-42M		15, 25, 40, 50	39
Ezi-SERVO-PG-BT-42L-PN□	EzM-42L		15, 25, 40, 50	47
Ezi-SERVO-PG-BT-42XL-PN□	EzM-42XL		15, 25, 40, 50	59

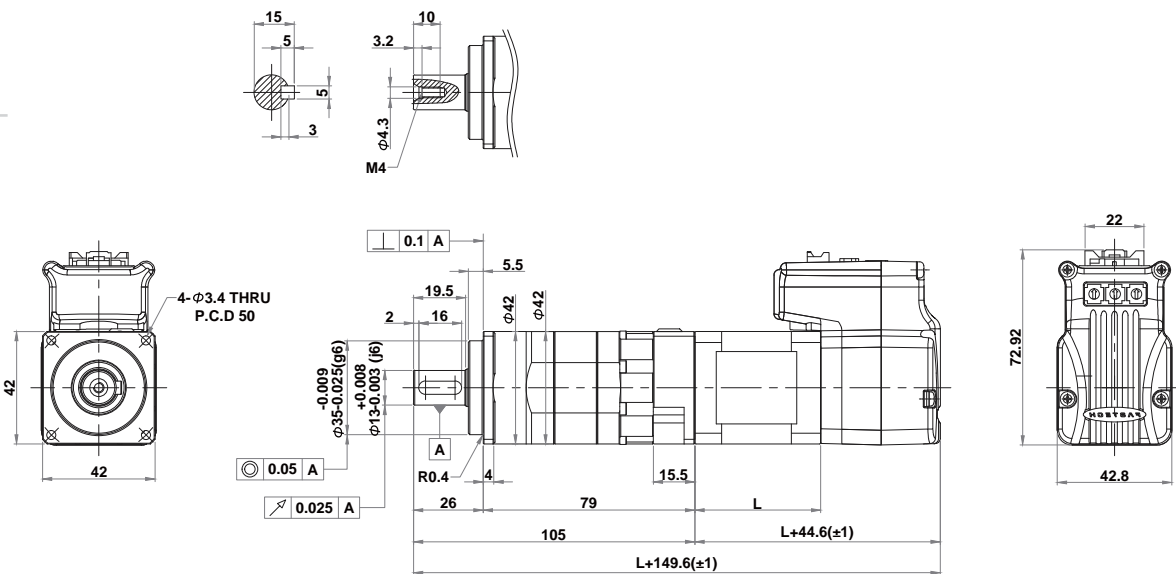

FASTECH Ezi-SERVO PG

Ezi-SERVO PG Series Specifications and Outline Drawings

◆ Ezi-SERVO BT Series Drawing (Motor Size 56mm)

Part Name	Part Name of Applied Motor	Gear Stage	□ Gear Ratio	Length (mm)
Ezi-SERVO-PG-BT-56S-PN□	EzM-56S	Single	3, 5, 8, 10	46
Ezi-SERVO-PG-BT-56M-PN□	EzM-56M		3, 5, 8, 10	54
Ezi-SERVO-PG-BT-56L-PN□	EzM-56L		3, 5, 8, 10	80

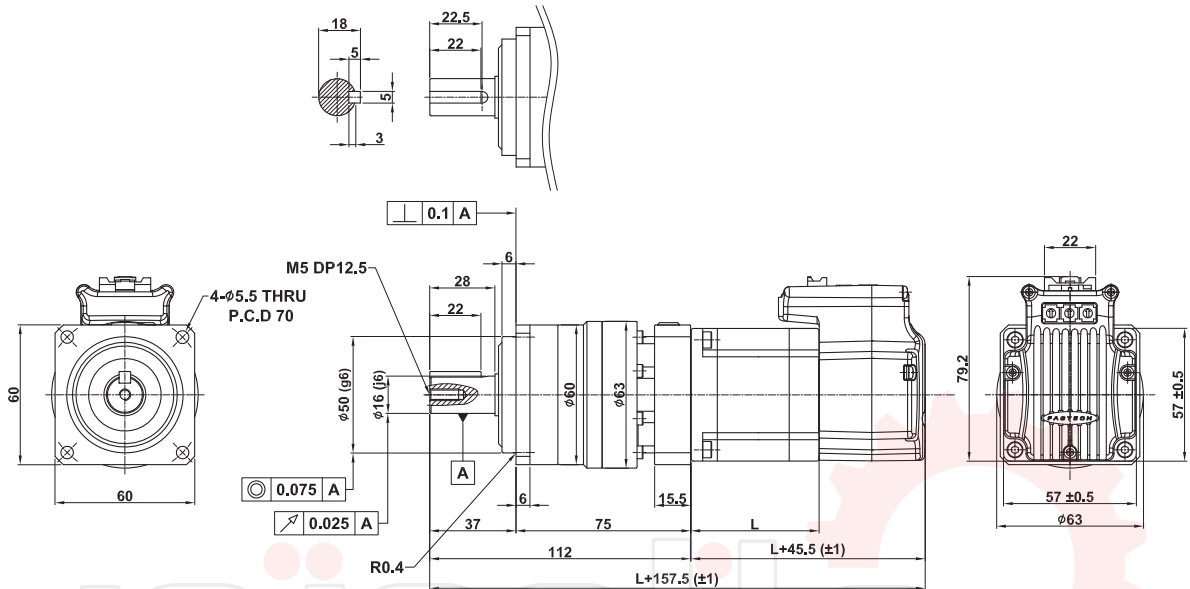

Part Name	Part Name of Applied Motor	Gear Stage	□ Gear Ratio	Length (mm)
Ezi-SERVO-PG-BT-56S-PN□	EzM-56S	Double	15, 25, 40, 50	46
Ezi-SERVO-PG-BT-56M-PN□	EzM-56M		15, 25, 40, 50	54
Ezi-SERVO-PG-BT-56L-PN□	EzM-56L		15, 25, 40, 50	80

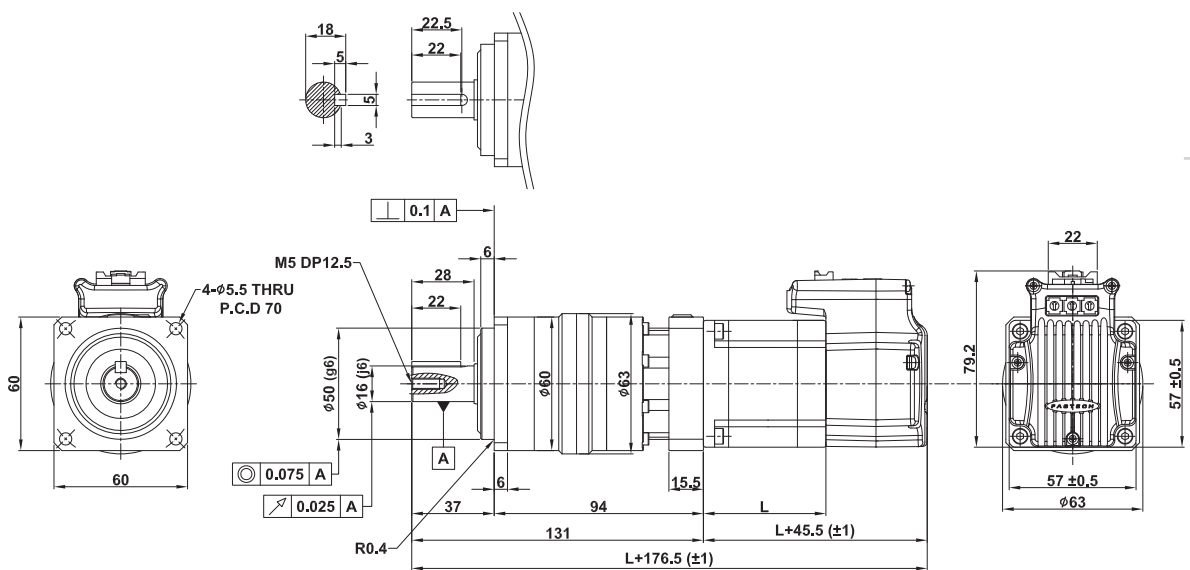

◆ Ezi-SERVO BT Series Drawing (Motor Size 60mm)

Part Name	Part Name of Applied Motor	Gear Stage	□ Gear Ratio	Length (mm)
Ezi-SERVO-PG-BT-60S-PN□	EzM-60S	Single	3, 5, 8, 10	46
Ezi-SERVO-PG-BT-60M-PN□	EzM-60M		3, 5, 8, 10	56
Ezi-SERVO-PG-BT-60L-PN□	EzM-60L		3, 5, 8, 10	90

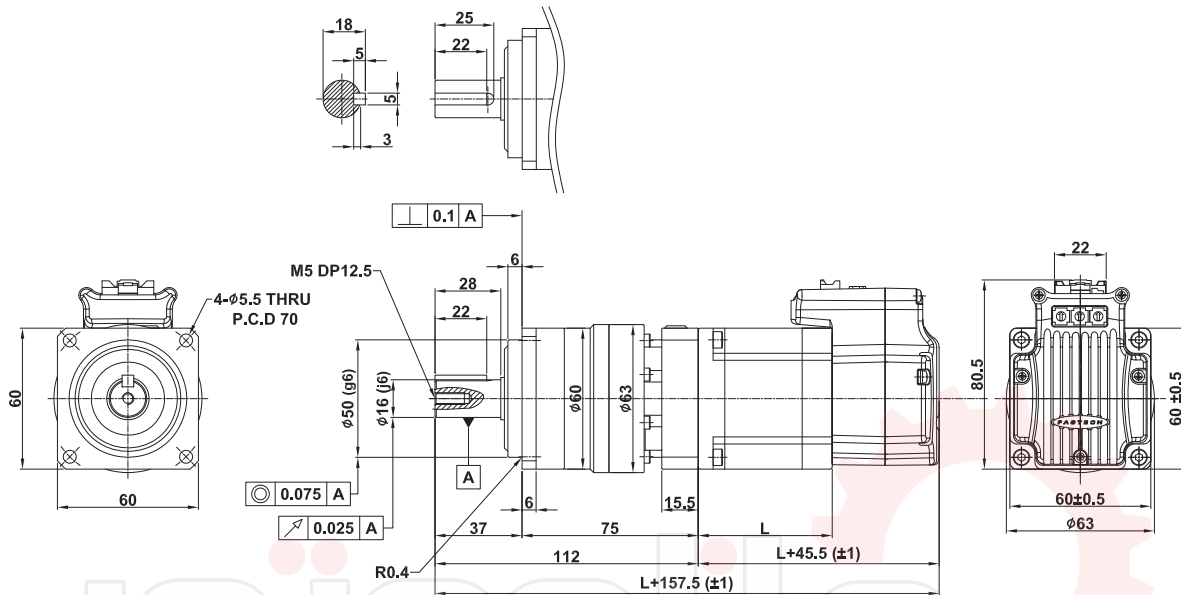

Part Name	Part Name of Applied Motor	Gear Stage	□ Gear Ratio	Length (mm)
Ezi-SERVO-PG-BT-60S-PN□	EzM-60S	Double	15, 25, 40, 50	46
Ezi-SERVO-PG-BT-60M-PN□	EzM-60M		15, 25, 40, 50	56
Ezi-SERVO-PG-BT-60L-PN□	EzM-60L		15, 25, 40, 50	90

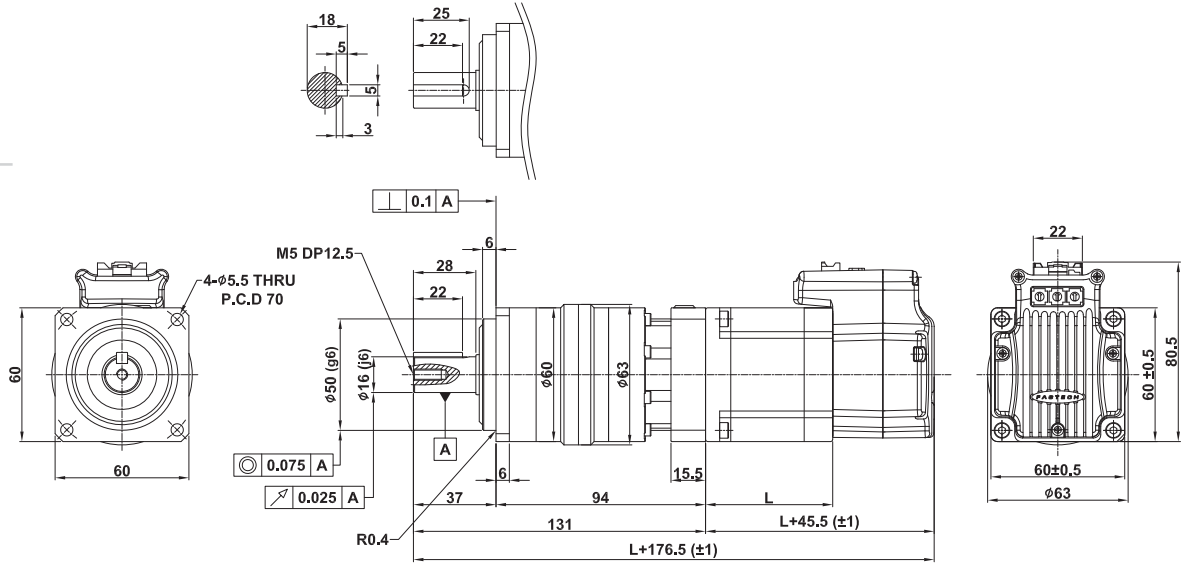

◆ Ezi-SERVO ALL Series Specifications (Motor Size 42mm)

Part Number	Max. Holding Torque (N · m)	Rotor Inertia Moment (Kg · m ²)	Backlash (min)	Angular transmission error (min)	Gear ratio	Resolution (10,000ppr basis)	Allowable Torque (N · m)	Max. Torque (N · m)	Allowable speed range (rpm)	Weight of unit (Kg)				
Ezi-SERVO-PG-ALL-42S-PN3	0,8	35x10 ⁻⁷	3	5	3	0,012 °	6	18	0~1000	0,97				
Ezi-SERVO-PG-ALL-42S-PN5	1,4				5	0,0072 °	9	18	0~600					
Ezi-SERVO-PG-ALL-42S-PN8	2,2				8	0,0045 °	9	18	0~375					
Ezi-SERVO-PG-ALL-42S-PN10	2,7				10	0,0036 °	6	12	0~333					
Ezi-SERVO-PG-ALL-42S-PN15	4,0		5	7	15	0,0024 °	6	12	0~300	1,07				
Ezi-SERVO-PG-ALL-42S-PN25	6,6				25	0,00144 °	9	18	0~120					
Ezi-SERVO-PG-ALL-42S-PN40	9,0				40	0,0009 °	9	18	0~75					
Ezi-SERVO-PG-ALL-42S-PN50					50	0,00072 °	9	18	0~60					
Ezi-SERVO-PG-ALL-42M-PN3	1,1				54x10 ⁻⁷	3	5	3	0,012 °		6	18	0~1000	1,04
Ezi-SERVO-PG-ALL-42M-PN5	1,9							5	0,0072 °		9	18	0~600	
Ezi-SERVO-PG-ALL-42M-PN8	3,0	8	0,0045 °	9				18	0~375					
Ezi-SERVO-PG-ALL-42M-PN10	3,7	10	0,0036 °	6				12	0~333					
Ezi-SERVO-PG-ALL-42M-PN15	5,4	5	7	15		0,0024 °	6	12	0~300	1,14				
Ezi-SERVO-PG-ALL-42M-PN25	9,0			25		0,00144 °	9	18	0~120					
Ezi-SERVO-PG-ALL-42M-PN40				40		0,0009 °	9	18	0~75					
Ezi-SERVO-PG-ALL-42M-PN50				50		0,00072 °	9	18	0~60					
Ezi-SERVO-PG-ALL-42L-PN3				1,4		77x10 ⁻⁷	3	5	3		0,012 °	6	18	0~1000
Ezi-SERVO-PG-ALL-42L-PN5	2,4			5					0,0072 °		9	18	0~600	
Ezi-SERVO-PG-ALL-42L-PN8	3,8	8	0,0045 °	9	18				0~375					
Ezi-SERVO-PG-ALL-42L-PN10	4,7	10	0,0036 °	6	12				0~333					
Ezi-SERVO-PG-ALL-42L-PN15	6,0	5	7	15	0,0024 °		6	12	0~300	1,20				
Ezi-SERVO-PG-ALL-42L-PN25	9,0			25	0,00144 °		9	18	0~120					
Ezi-SERVO-PG-ALL-42L-PN40				40	0,0009 °		9	18	0~75					
Ezi-SERVO-PG-ALL-42L-PN50				50	0,00072 °		9	18	0~60					
Ezi-SERVO-PG-ALL-42XL-PN3				1,8	114x10 ⁻⁷		3	5	3		0,012 °	6	18	0~1000
Ezi-SERVO-PG-ALL-42XL-PN5	3,0			5					0,0072 °		9	18	0~600	
Ezi-SERVO-PG-ALL-42XL-PN8	4,8	8	0,0045 °	9		18			0~375					
Ezi-SERVO-PG-ALL-42XL-PN10	6,0	10	0,0036 °	6		12			0~333					
Ezi-SERVO-PG-ALL-42XL-PN15		15	0,0024 °	6		12	0~300	1,33						
Ezi-SERVO-PG-ALL-42XL-PN25	9,0	25	0,00144 °	9		18	0~120							
Ezi-SERVO-PG-ALL-42XL-PN40		40	0,0009 °	9		18	0~75							
Ezi-SERVO-PG-ALL-42XL-PN50		50	0,00072 °	9		18	0~60							

- * Possible to choose and set one of encoder resolution among 500, 1000, 1600, 2000, 3600, 5000, 6400, 7200, 10000
- * Allowable Torque is max. torque that can be added to gearbox output shaft during constant speed of operation
- * Max. Torque is max. torque that can be added to gearbox output shaft during Acceleration and deceleration of inertia load as like start and stop.
- * Allowable Torque and Max. Torque is only specifications from mechanical part of gearbox so please refer to speed-torque curve to check output torque of motor combined with gearbox.
- * During normal operation of constant speed, please drive less than Max. allowable torque except starts and stops because excess of permissible torque of gearbox can cause shortened life.
- * The direction of rotation of the motor and output shaft of gearbox is the same.

◆ Ezi-SERVO ALL Series Specifications (Motor Size 56mm)

Part Number	Max. Holding Torque (N · m)	Rotor Inertia Moment (Kg · m ²)	Backlash (min)	Angular transmission error (min)	Gear ratio	Resolution (10,000ppr basis)	Allowable Torque (N · m)	Max. Torque (N · m)	Allowable speed range (rpm)	Weight of unit (Kg)
Ezi-SERVO PG-ALL-56S-PN3	1,6	120x10 ⁻⁷	3	5	3	0,012 °	18	35	0~1000	1,9
Ezi-SERVO PG-ALL-56S-PN5	2,7				5	0,0072 °	27	50	0~600	
Ezi-SERVO PG-ALL-56S-PN8	4,3				8	0,0045 °	27	50	0~375	
Ezi-SERVO PG-ALL-56S-PN10	5,3				10	0,0036 °	18	35	0~333	
Ezi-SERVO PG-ALL-56S-PN15	7,7				15	0,0024 °	18	35	0~300	2,1
Ezi-SERVO PG-ALL-56S-PN25	12,9				25	0,00144 °	27	50	0~120	
Ezi-SERVO PG-ALL-56S-PN40	20,6				40	0,0009 °	27	50	0~75	
Ezi-SERVO PG-ALL-56S-PN50	25,8				50	0,00072 °	27	50	0~60	
Ezi-SERVO PG-ALL-56M-PN3	2,6	200x10 ⁻⁷	3	5	3	0,012 °	18	35	0~1000	2,1
Ezi-SERVO PG-ALL-56M-PN5	4,4				5	0,0072 °	27	50	0~600	
Ezi-SERVO PG-ALL-56M-PN8	7,0				8	0,0045 °	27	50	0~375	
Ezi-SERVO PG-ALL-56M-PN10	8,7				10	0,0036 °	18	35	0~333	
Ezi-SERVO PG-ALL-56M-PN15	12,7				15	0,0024 °	18	35	0~300	2,3
Ezi-SERVO PG-ALL-56M-PN25	21,1				25	0,00144 °	27	50	0~120	
Ezi-SERVO PG-ALL-56M-PN40	27,0				40	0,0009 °	27	50	0~75	
Ezi-SERVO PG-ALL-56M-PN50					50	0,00072 °	27	50	0~60	
Ezi-SERVO PG-ALL-56L-PN3	4,3	480x10 ⁻⁷	3	5	3	0,012 °	18	35	0~1000	2,55
Ezi-SERVO PG-ALL-56L-PN5	7,2				5	0,0072 °	27	50	0~600	
Ezi-SERVO PG-ALL-56L-PN8	11,4				8	0,0045 °	27	50	0~375	
Ezi-SERVO PG-ALL-56L-PN10	14,3				10	0,0036 °	18	35	0~333	
Ezi-SERVO PG-ALL-56L-PN15	18,0				15	0,0024 °	18	35	0~300	2,75
Ezi-SERVO PG-ALL-56L-PN25	27,0				25	0,00144 °	27	50	0~120	
Ezi-SERVO PG-ALL-56L-PN40					40	0,0009 °	27	50	0~75	
Ezi-SERVO PG-ALL-56L-PN50					50	0,00072 °	27	50	0~60	

- * Possible to choose and set one of encoder resolution among 500, 1000, 1600, 2000, 3600, 5000, 6400, 7200, 10000
- * Allowable Torque is max. torque that can be added to gearbox output shaft during constant speed of operation
- * Max. Torque is max. torque that can be added to gearbox output shaft during Acceleration and deceleration of inertia load as like start and stop.
- * Allowable Torque and Max. Torque is only specifications from mechanical part of gearbox so please refer to speed-torque curve to check output torque of motor combined with gearbox.
- * During normal operation of constant speed, please drive less than Max. allowable torque except starts and stops because excess of permissible torque of gearbox can cause shortened life.
- * The direction of rotation of the motor and output shaft of gearbox is the same.

◆ Ezi-SERVO ALL Series Specifications (Motor Size 60mm)

Part Number	Max. Holding Torque (N · m)	Rotor Inertia Moment (Kg · m ²)	Backlash (min)	Angular transmission error (min)	Gear ratio	Resolution (10,000ppr basis)	Allowable Torque (N · m)	Max. Torque (N · m)	Allowable speed range (rpm)	Weight of unit (Kg)
Ezi-SERVO-PG-ALL-60S-PN3	2,6	140x10 ⁻⁷	3	5	3	0,012 °	27	50	0~1000	2,44
Ezi-SERVO-PG-ALL-60S-PN5	4,4				5	0,0072 °	27	50	0~600	
Ezi-SERVO-PG-ALL-60S-PN8	7,0				8	0,0045 °	27	50	0~375	
Ezi-SERVO-PG-ALL-60S-PN10	8,8				10	0,0036 °	18	35	0~333	
Ezi-SERVO-PG-ALL-60S-PN15	12,7				15	0,0024 °	18	35	0~300	2,64
Ezi-SERVO-PG-ALL-60S-PN25	21,2				25	0,00144 °	27	50	0~120	
Ezi-SERVO-PG-ALL-60S-PN40	27,0				40	0,0009 °	27	50	0~75	
Ezi-SERVO-PG-ALL-60S-PN50					50	0,00072 °	27	50	0~60	
Ezi-SERVO-PG-ALL-60M-PN3	3,6	320x10 ⁻⁷	3	5	3	0,012 °	27	50	0~1000	2,74
Ezi-SERVO-PG-ALL-60M-PN5	6,0				5	0,0072 °	27	50	0~600	
Ezi-SERVO-PG-ALL-60M-PN8	9,6				8	0,0045 °	27	50	0~375	
Ezi-SERVO-PG-ALL-60M-PN10	12,0				10	0,0036 °	18	35	0~333	
Ezi-SERVO-PG-ALL-60M-PN15	17,4				15	0,0024 °	18	35	0~300	2,94
Ezi-SERVO-PG-ALL-60M-PN25	27,0				25	0,00144 °	27	50	0~120	
Ezi-SERVO-PG-ALL-60M-PN40					40	0,0009 °	27	50	0~75	
Ezi-SERVO-PG-ALL-60M-PN50					50	0,00072 °	27	50	0~60	
Ezi-SERVO-PG-ALL-60L-PN3		7,1	800x10 ⁻⁷	3	5	3	0,012 °	27	50	0~1000
Ezi-SERVO-PG-ALL-60L-PN5	11,9	5				0,0072 °	27	50	0~600	
Ezi-SERVO-PG-ALL-60L-PN8	19,0	8				0,0045 °	27	50	0~375	
Ezi-SERVO-PG-ALL-60L-PN10	18,0	10				0,0036 °	18	35	0~333	
Ezi-SERVO-PG-ALL-60L-PN15		15				0,0024 °	18	35	0~300	3,64
Ezi-SERVO-PG-ALL-60L-PN25		25				0,00144 °	27	50	0~120	
Ezi-SERVO-PG-ALL-60L-PN40		27,0				40	0,0009 °	27	50	
Ezi-SERVO-PG-ALL-60L-PN50	50					0,00072 °	27	50	0~60	

- * Possible to choose and set one of encoder resolution among 500, 1000, 1600, 2000, 3600, 5000, 6400, 7200, 10000
- * Allowable Torque is max. torque that can be added to gearbox output shaft during constant speed of operation
- * Max. Torque is max. torque that can be added to gearbox output shaft during Acceleration and deceleration of inertia load as like start and stop.
- * Allowable Torque and Max. Torque is only specifications from mechanical part of gearbox so please refer to speed-torque curve to check output torque of motor combined with gearbox.
- * During normal operation of constant speed, please drive less than Max. allowable torque except starts and stops because excess of permissible torque of gearbox can cause shortened life.
- * The direction of rotation of the motor and output shaft of gearbox is the same.

◆ Ezi-SERVO ALL Series Drawing (Motor Size 42mm)

Part Name	Part Name of Applied Motor	Gear Stage	□ Gear Ratio	Length (mm)
Ezi-SERVO-PG-ALL-42S-PN □	EzM-42S	Single	3, 5, 8, 10	33
Ezi-SERVO-PG-ALL-42M-PN □	EzM-42M		3, 5, 8, 10	39
Ezi-SERVO-PG-ALL-42L-PN □	EzM-42L		3, 5, 8, 10	47
Ezi-SERVO-PG-ALL-42XL-PN □	EzM-42XL		3, 5, 8, 10	59

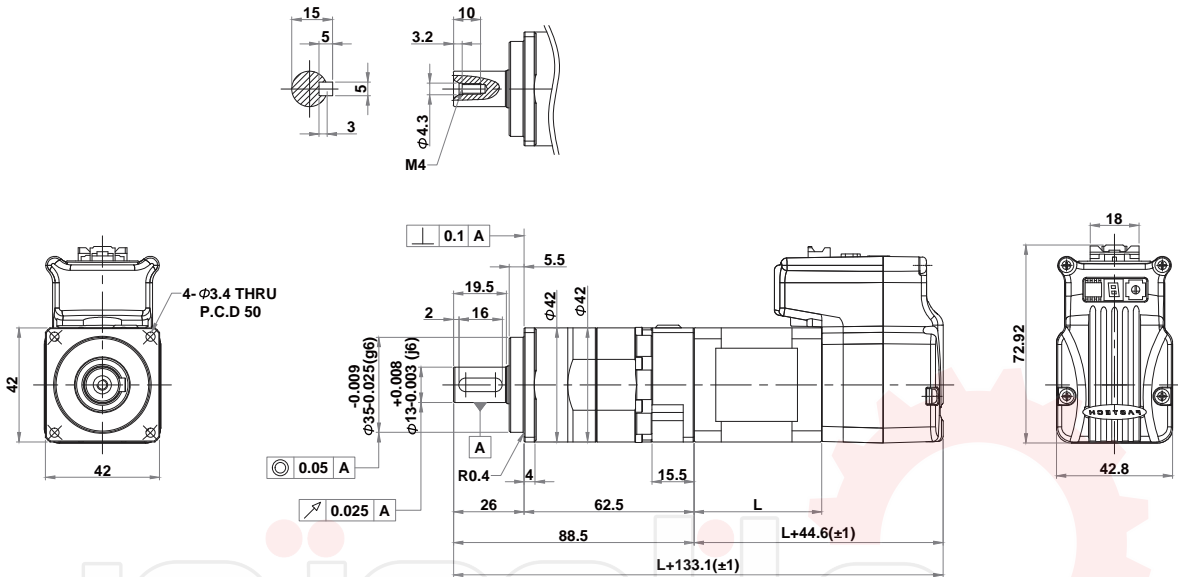

Part Name	Part Name of Applied Motor	Gear Stage	□ Gear Ratio	Length (mm)
Ezi-SERVO-PG-ALL-42S-PN □	EzM-42S	Double	15, 25, 40, 50	33
Ezi-SERVO-PG-ALL-42M-PN □	EzM-42M		15, 25, 40, 50	39
Ezi-SERVO-PG-ALL-42L-PN □	EzM-42L		15, 25, 40, 50	47
Ezi-SERVO-PG-ALL-42XL-PN □	EzM-42XL		15, 25, 40, 50	59

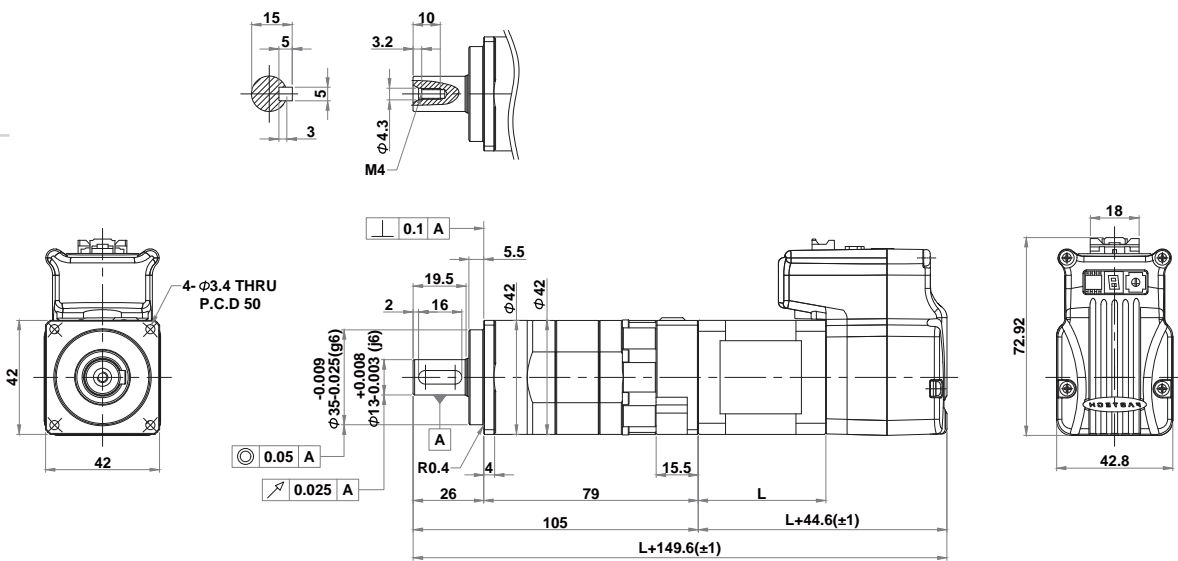

◆ Ezi-SERVO ALL Series Drawing (Motor Size 56mm)

Part Name	Part Name of Applied Motor	Gear Stage	□ Gear Ratio	Length (mm)
Ezi-SERVO-PG-ALL-56S-PN □	EzM-56S	Single	3, 5, 8, 10	46
Ezi-SERVO-PG-ALL-56M-PN □	EzM-56M		3, 5, 8, 10	54
Ezi-SERVO-PG-ALL-56L-PN □	EzM-56L		3, 5, 8, 10	80

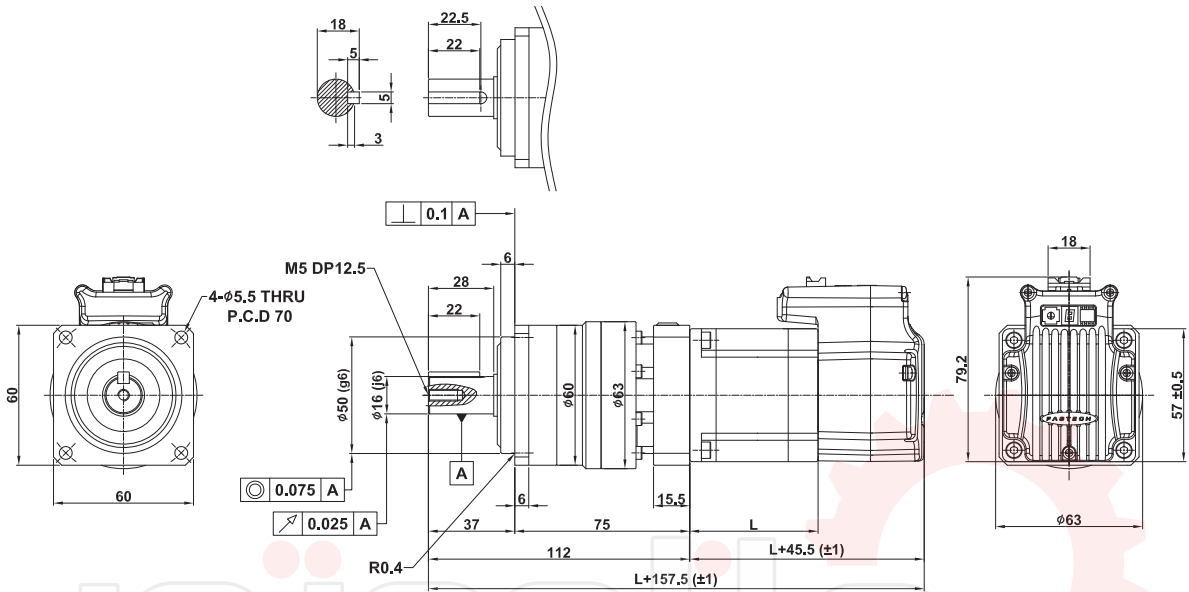

Part Name	Part Name of Applied Motor	Gear Stage	□ Gear Ratio	Length (mm)
Ezi-SERVO-PG-ALL-56S-PN □	EzM-56S	Double	15, 25, 40, 50	46
Ezi-SERVO-PG-ALL-56M-PN □	EzM-56M		15, 25, 40, 50	54
Ezi-SERVO-PG-ALL-56L-PN □	EzM-56L		15, 25, 40, 50	80

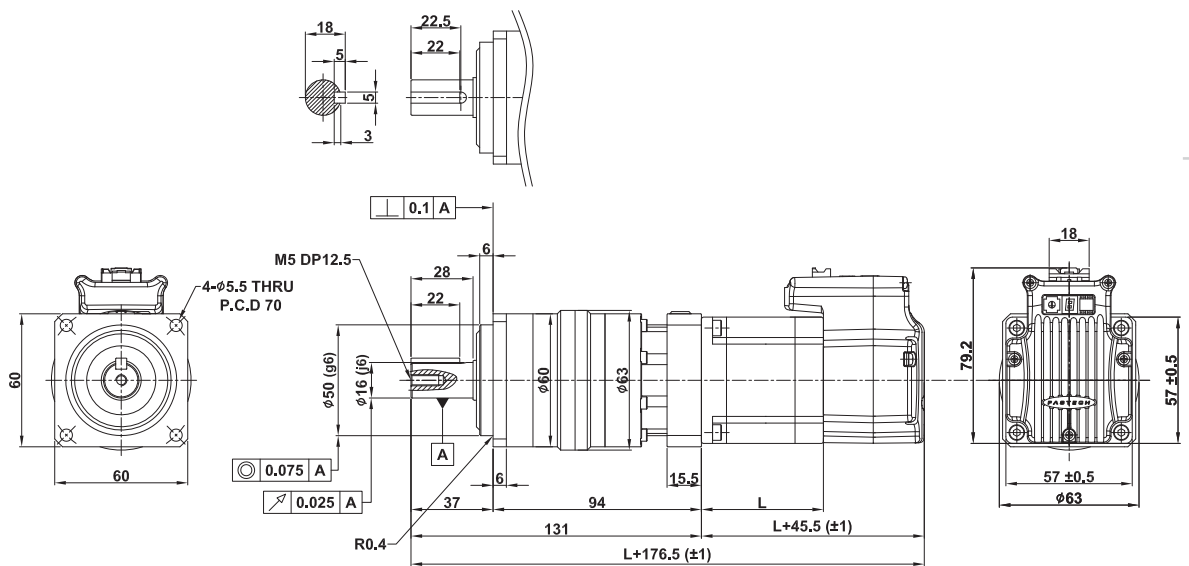

◆ Ezi-SERVO ALL Series Drawing (Motor Size 60mm)

Part Name	Part Name of Applied Motor	Gear Stage	□ Gear Ratio	Length (mm)
Ezi-SERVO-PG-ALL-60S-PN □	EzM-60S	Single	3, 5, 8, 10	46
Ezi-SERVO-PG-ALL-60M-PN □	EzM-60M		3, 5, 8, 10	56
Ezi-SERVO-PG-ALL-60L-PN □	EzM-60L		3, 5, 8, 10	90

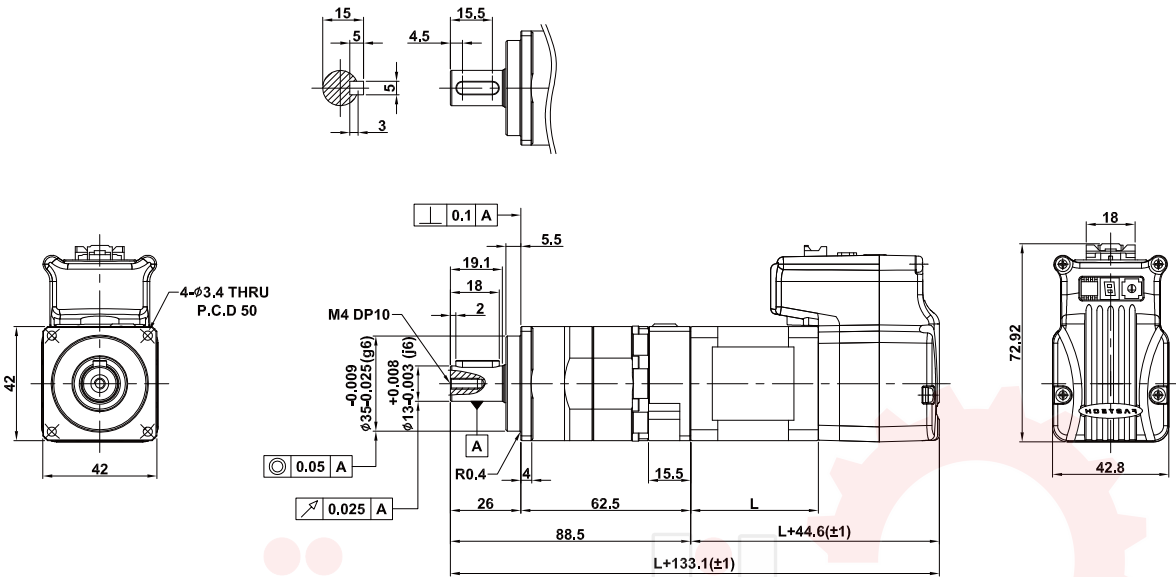

Part Name	Part Name of Applied Motor	Gear Stage	□ Gear Ratio	Length (mm)
Ezi-SERVO-PG-ALL-60S-PN □	EzM-60S	Double	15, 25, 40, 50	46
Ezi-SERVO-PG-ALL-60M-PN □	EzM-60M		15, 25, 40, 50	56
Ezi-SERVO-PG-ALL-60L-PN □	EzM-60L		15, 25, 40, 50	90

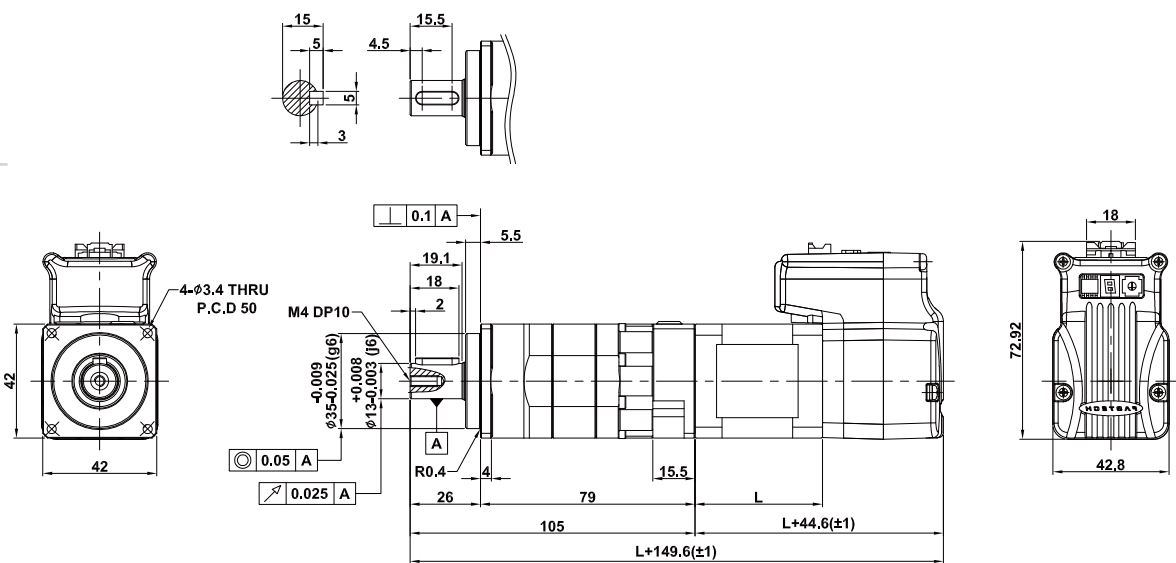

● Ezi-SERVO PG Series Rotational Speed – Torque Specifications (Motor Size 42mm)

Measurement Conditions : Motor Voltage = DC40V, Motor Current = Rated Current 1,2A

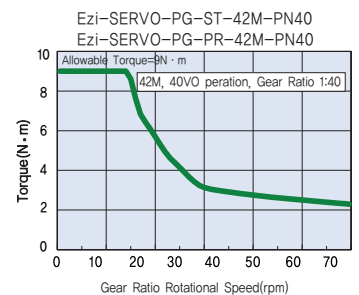
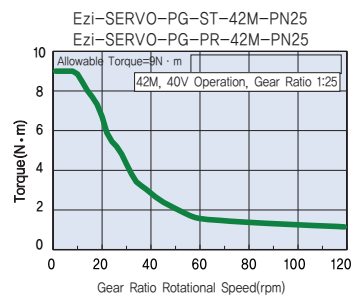
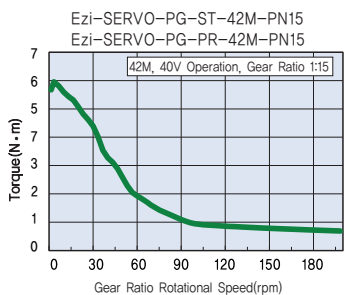
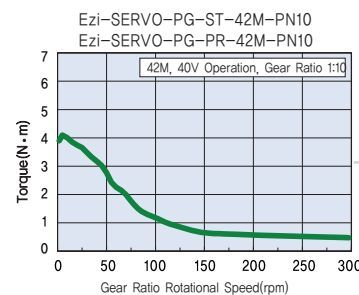
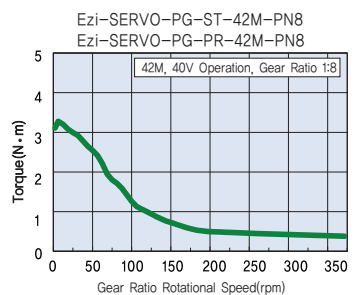
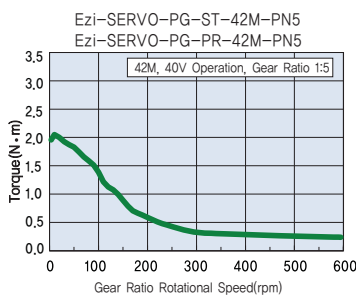
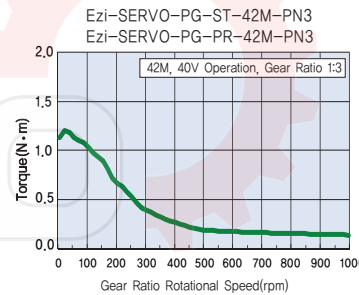
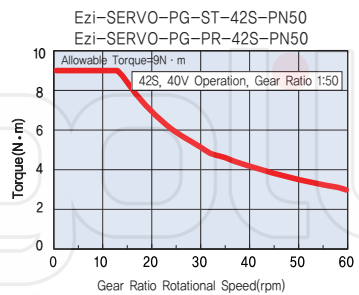
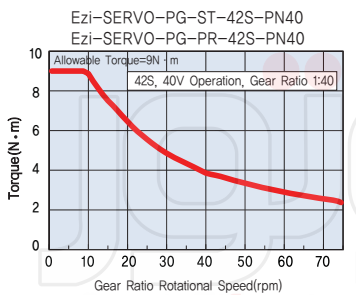
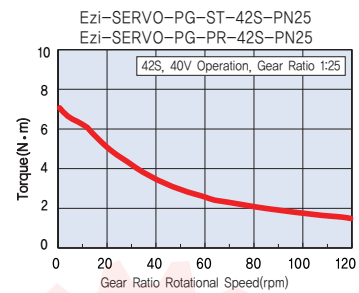
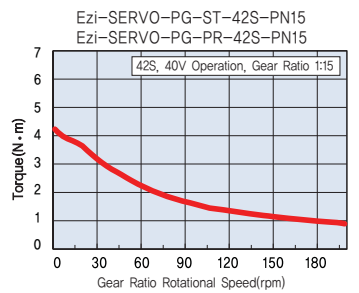
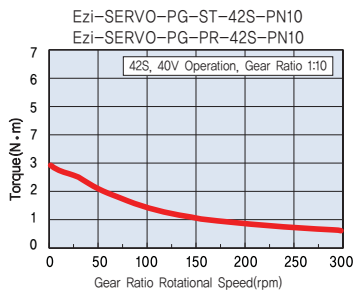
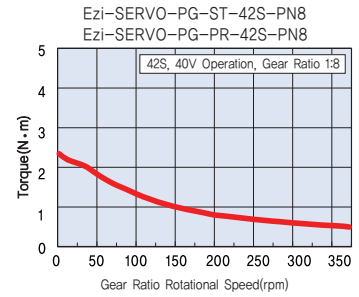
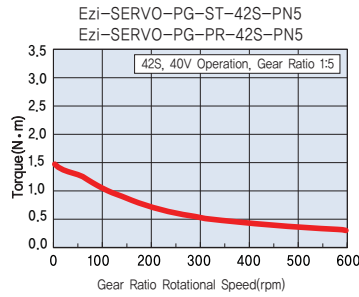
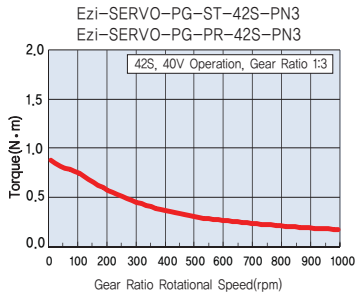

● Ezi-SERVO PG Series Rotational Speed – Torque Specifications (Motor Size 42mm)

Measurement Conditions : Motor Voltage = DC40V, Motor Current = Rated Current 1.2A

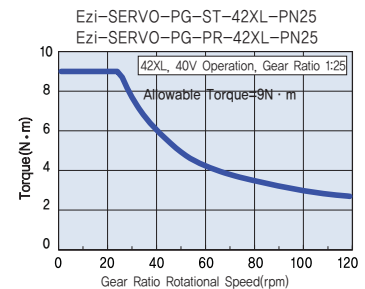
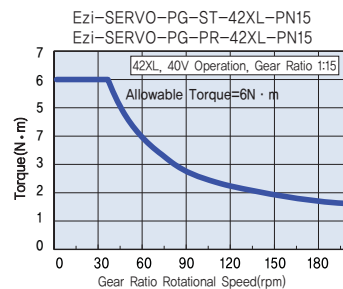
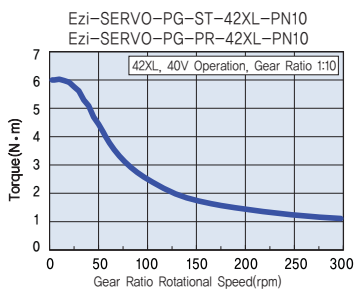
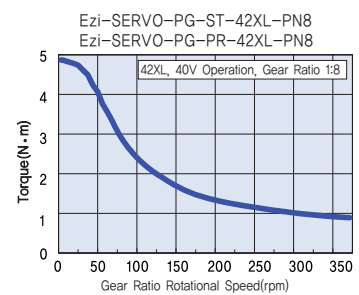
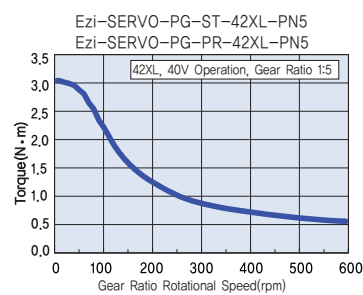
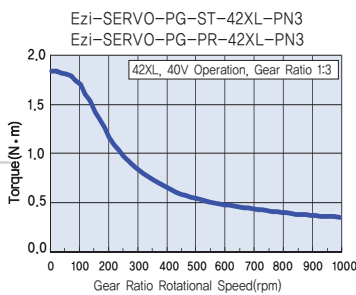
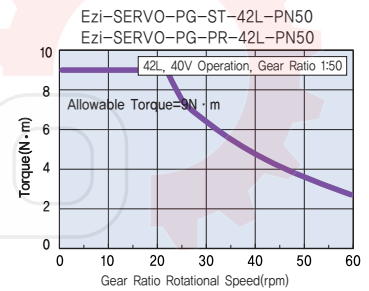
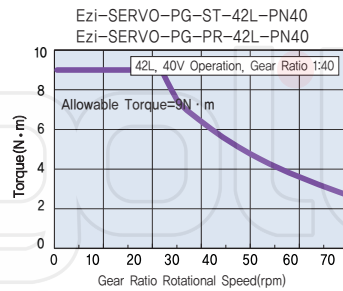
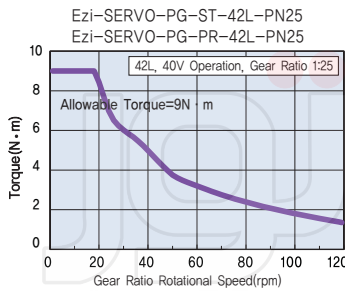
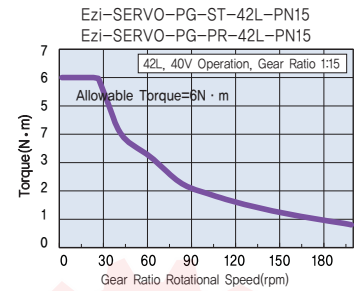
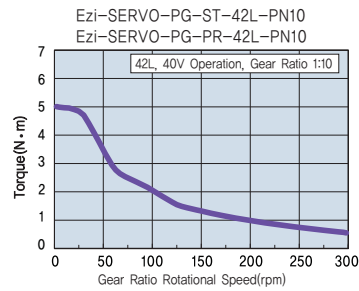
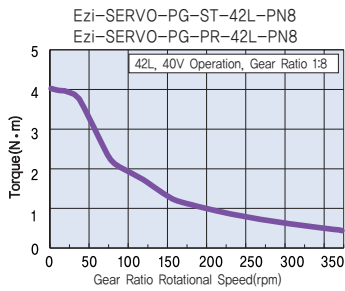
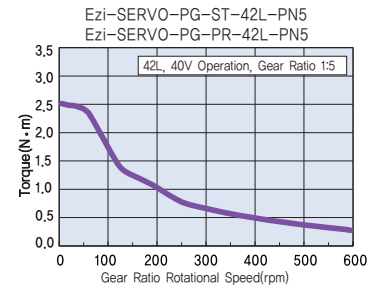
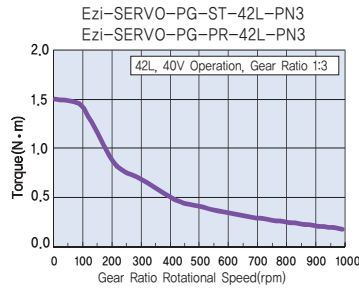
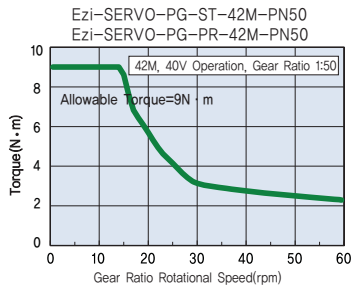

● Ezi-SERVO PG Series Rotational Speed – Torque Specifications (Motor Size 42mm)

Measurement Conditions : Motor Voltage = DC40V, Motor Current = Rated Current 1,2A

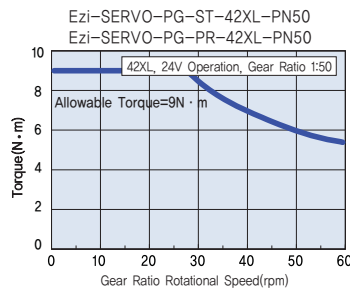
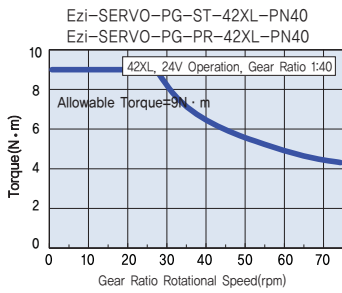

● Ezi-SERVO PG Series Rotational Speed – Torque Specifications (Motor Size 56mm)

Measurement Conditions : Motor Voltage = DC40V, Motor Current = Rated Current 3A

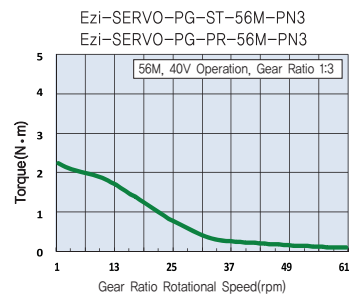
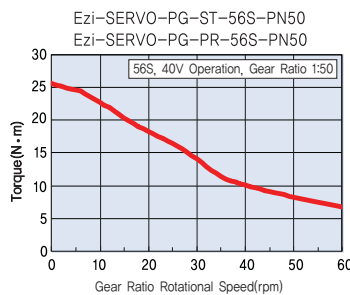
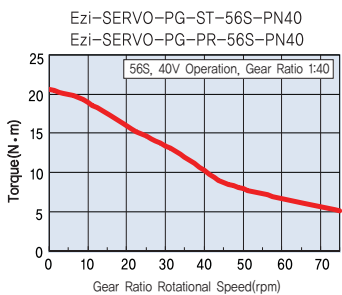
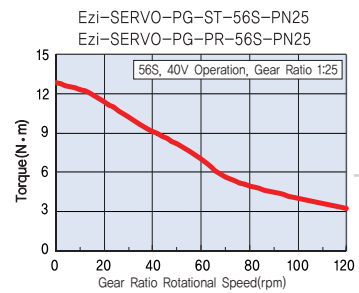
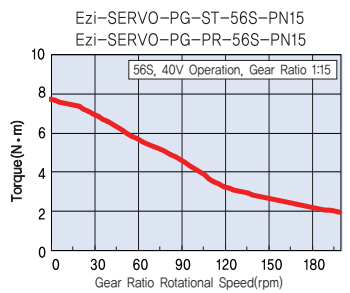
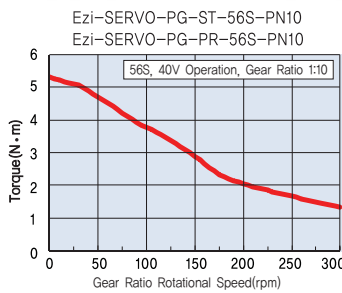
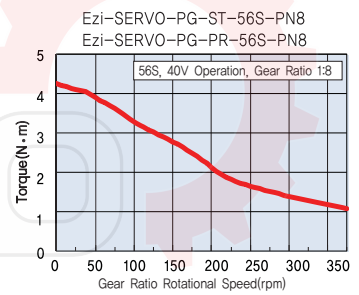
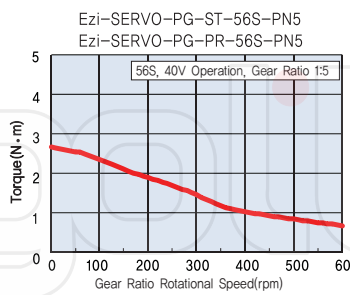
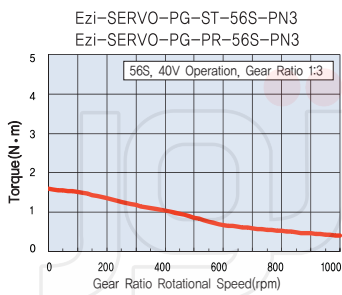

● Ezi-SERVO PG Series Rotational Speed – Torque Specifications (Motor Size 56mm)

Measurement Conditions : Motor Voltage = DC40V, Motor Current = Rated Current 3A

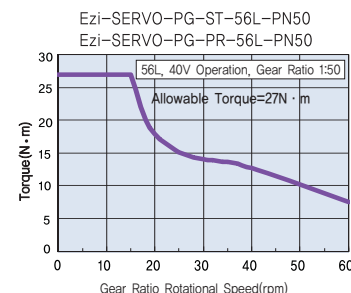
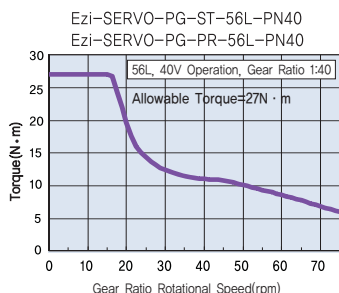
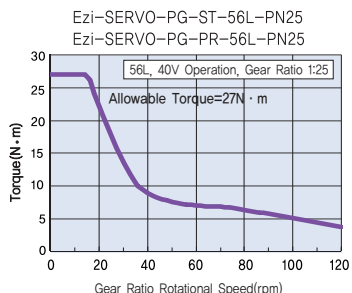
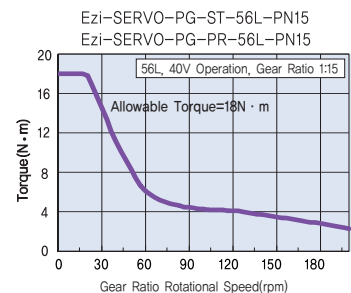
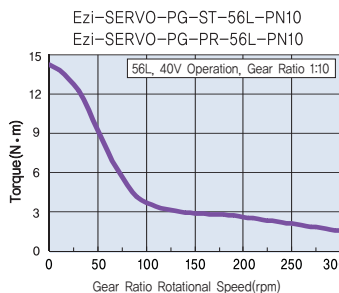
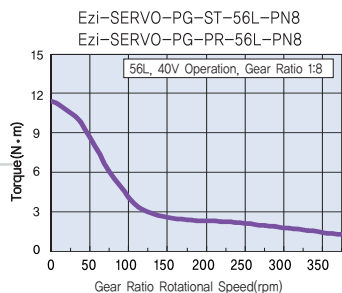
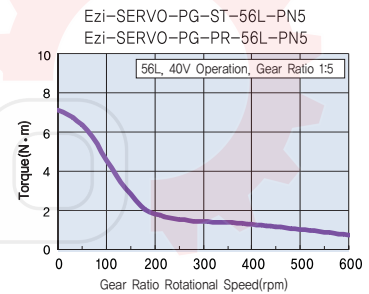
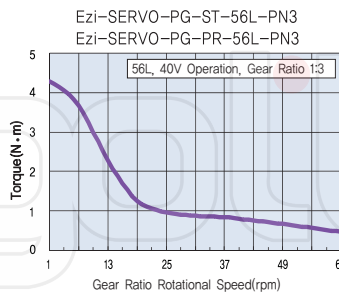
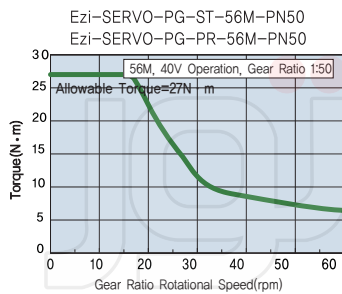
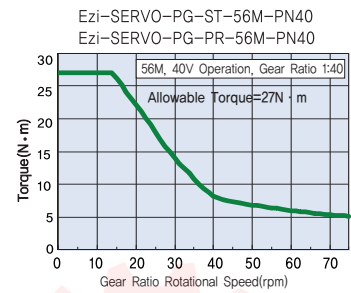
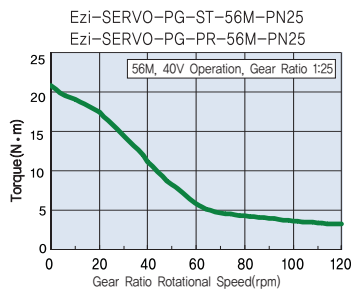
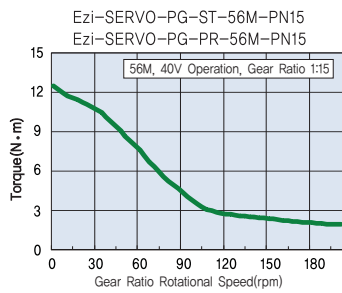
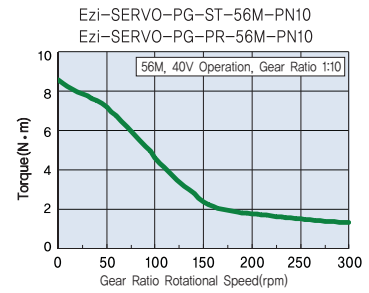
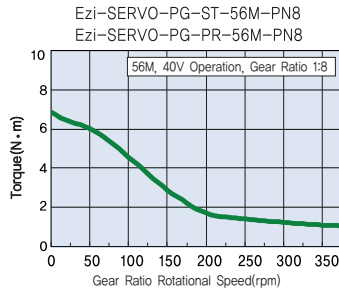
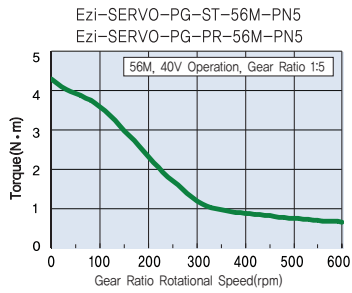

● Ezi-SERVO PG Series Rotational Speed – Torque Specifications (Motor Size 60mm)

Measurement Conditions : Motor Voltage = DC40V, Motor Current = Rated Current 4A

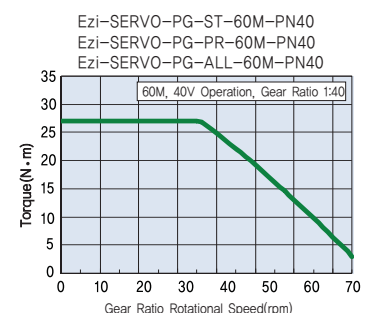
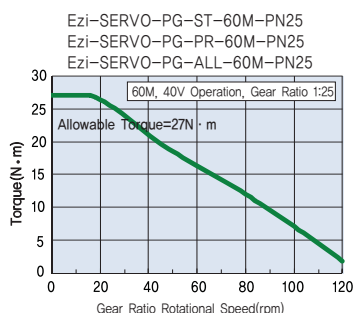
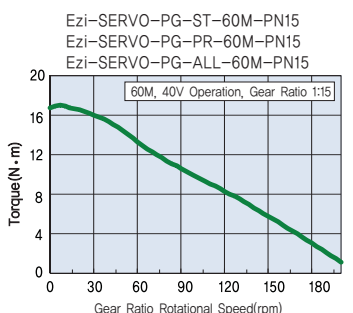
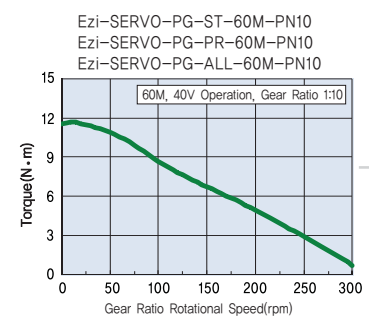
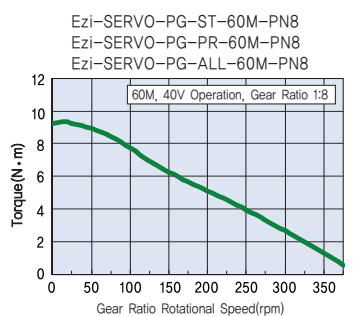
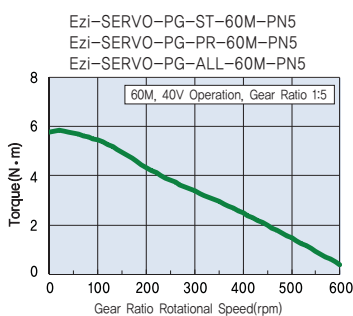
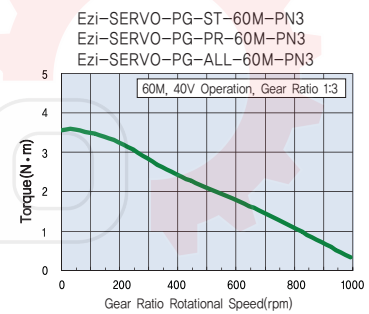
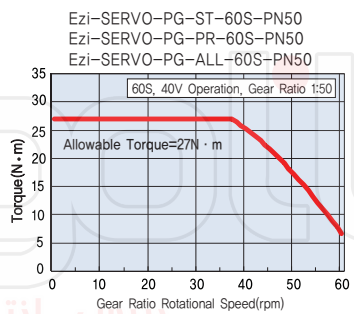
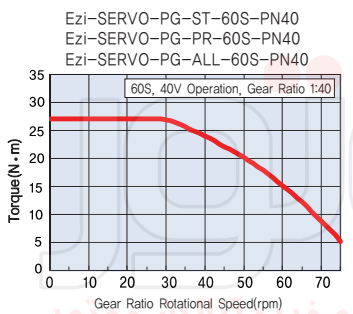
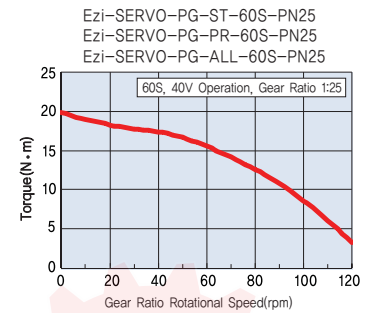
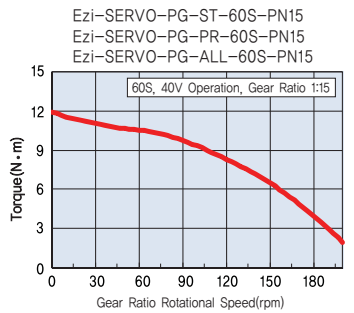
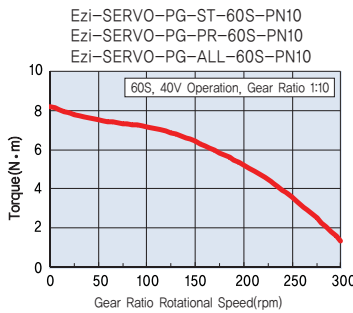
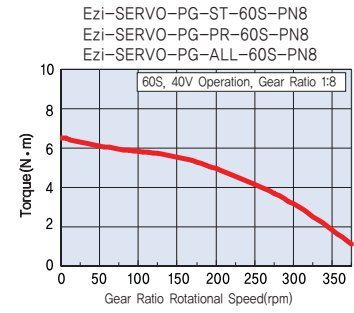
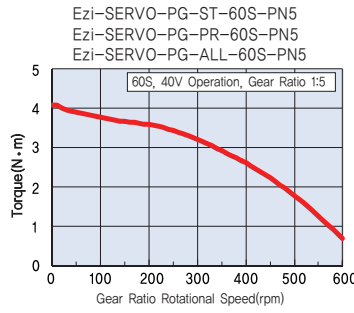
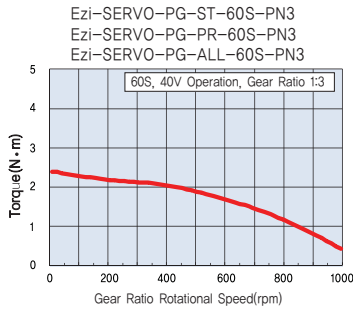

● Ezi-SERVO PG Series Rotational Speed – Torque Specifications (Motor Size 60mm)

Measurement Conditions : Motor Voltage = DC40V, Motor Current = Rated Current 4A

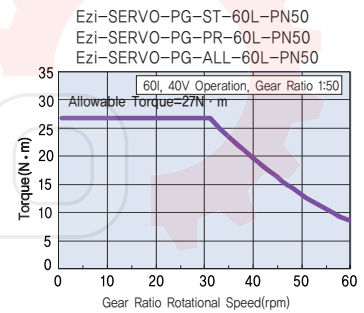
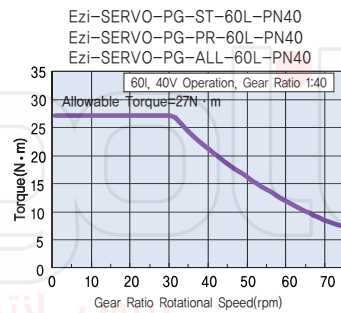
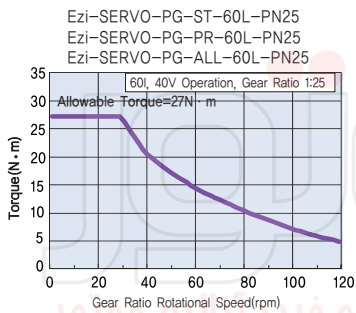
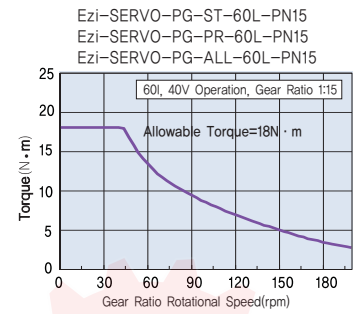
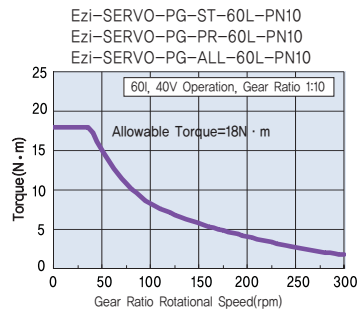
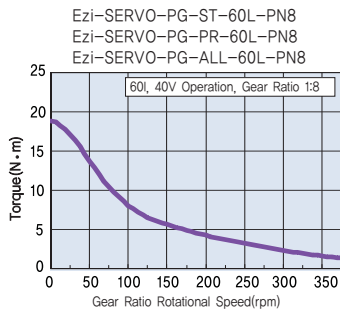
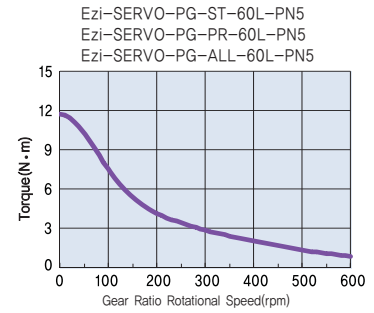
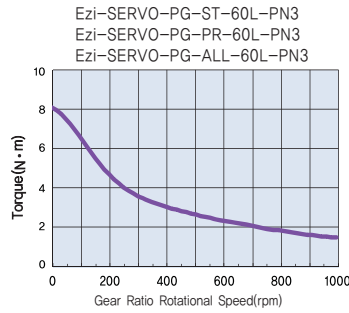
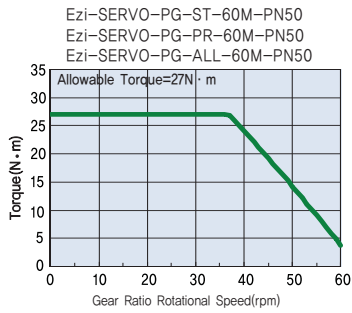

Ezi-SERVO PG Series Rotational Speed – Torque Specifications (Motor Size 86mm)

Measurement Conditions : Motor Voltage = DC70V, Motor Current = Rated Current 6A

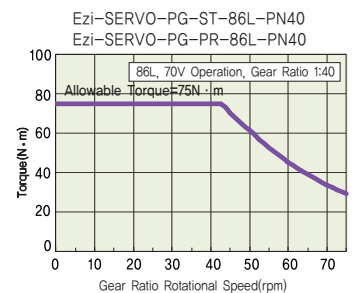
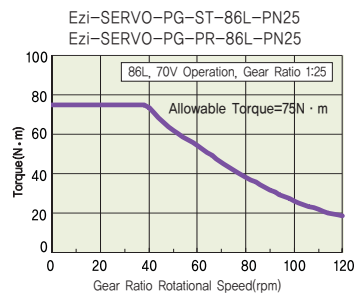
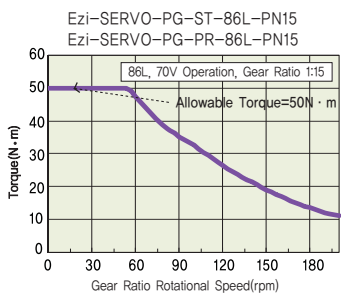
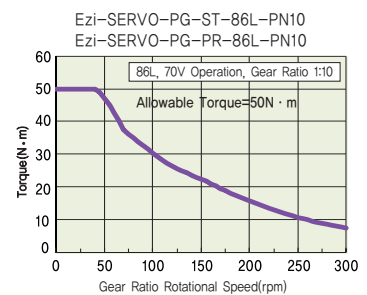
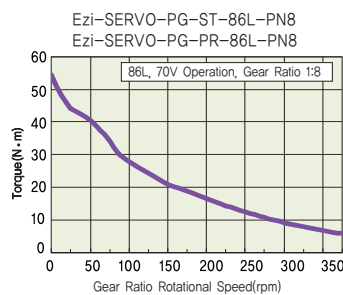
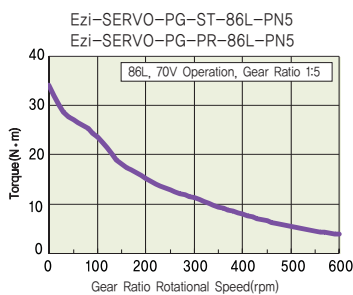
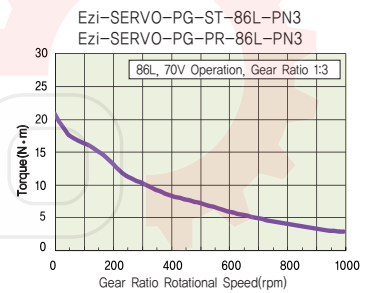
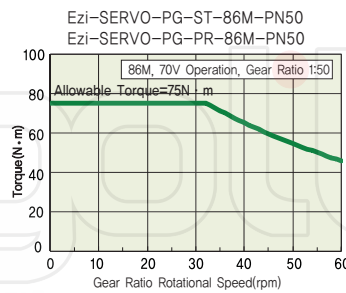
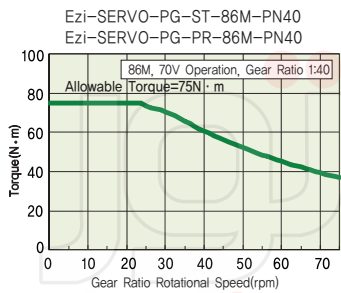
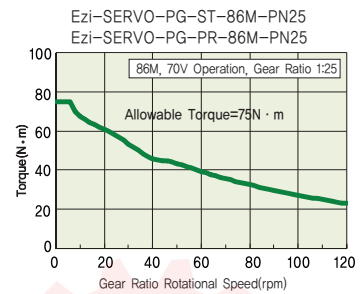
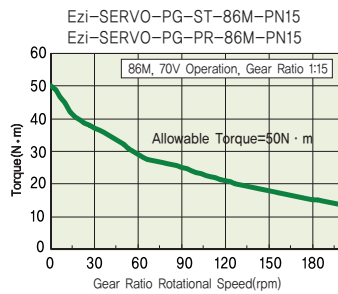
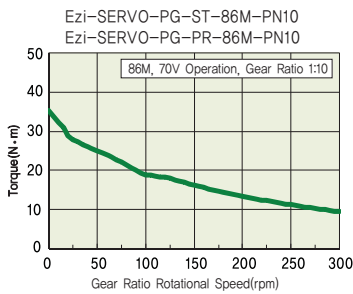
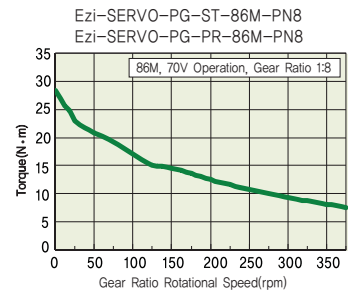
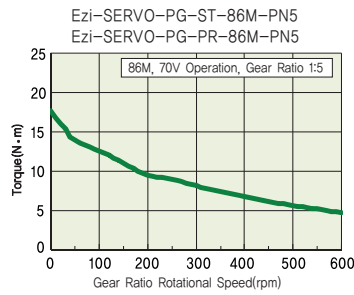
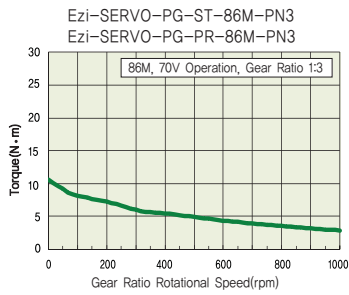

بررسی، انتخاب و فرید آنلاین موتور

● Ezi-SERVO PG Series Rotational Speed – Torque Specifications (Motor Size 86mm)

Measurement Conditions : Motor Voltage = DC70V, Motor Current = Rated Current 6A

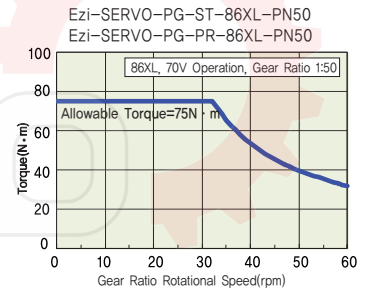
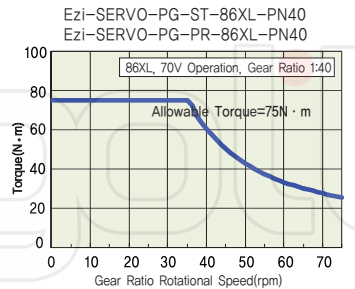
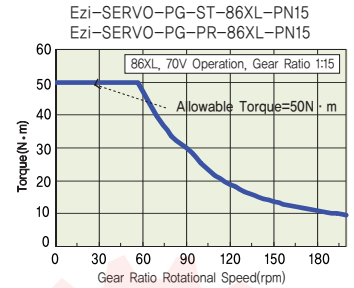
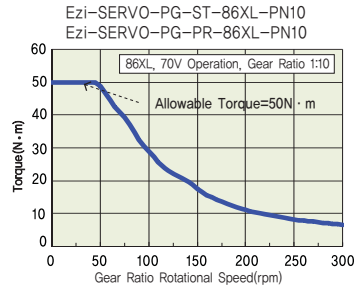
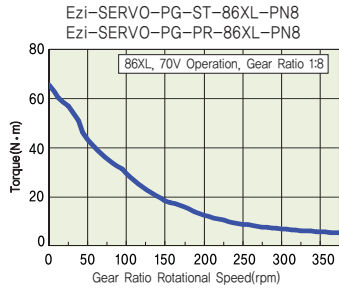
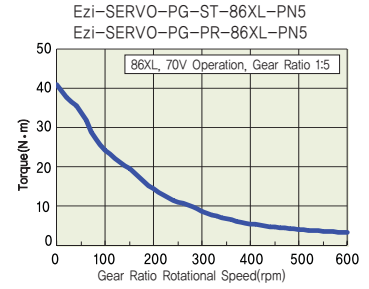
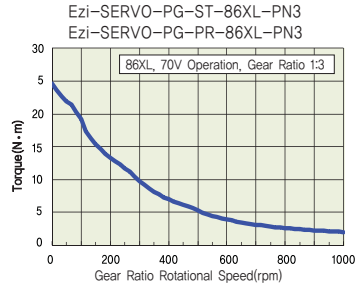
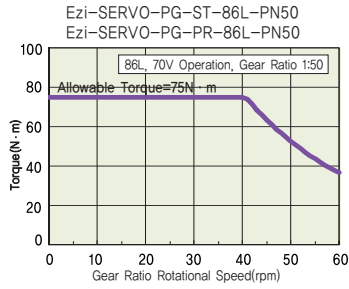

FASTECH Ezi-SERVO PG

بررسی، انتخاب و فرید آنلاین موتور

● Ezi-SERVO PG Series Rotational Speed – Torque Specifications (Motor Size 42mm)

Measurement Conditions : Motor Voltage = DC24V, Motor Current = Rated Current 1.2A

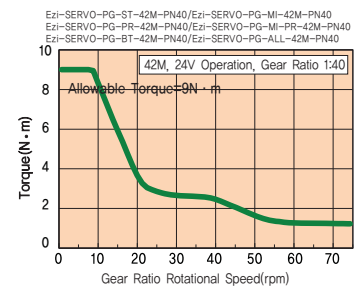
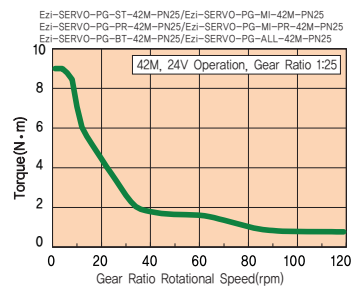
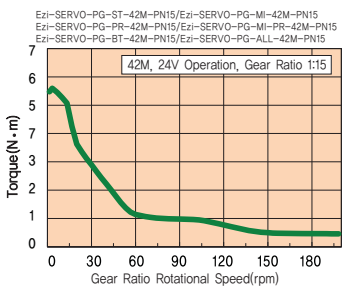
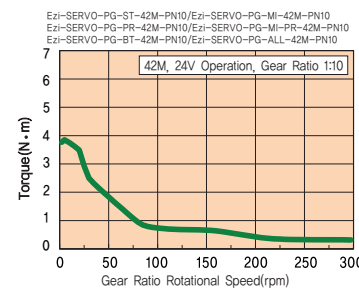
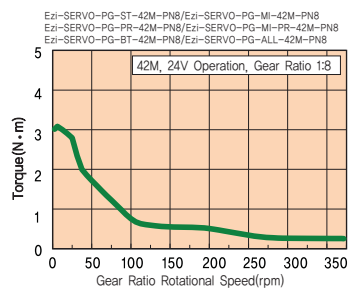
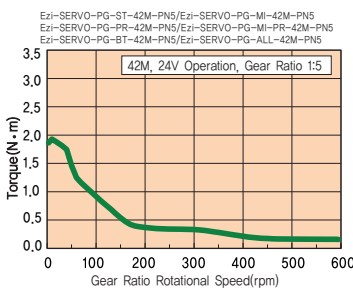
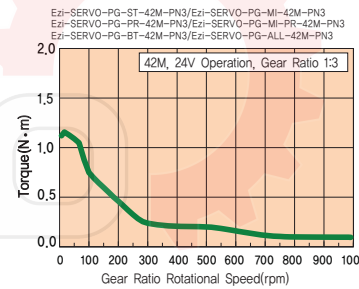
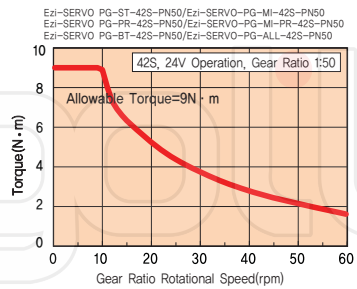
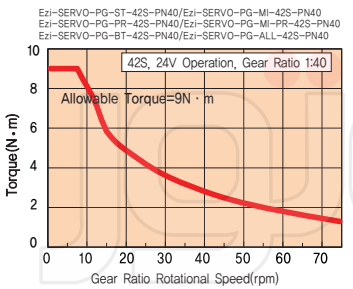
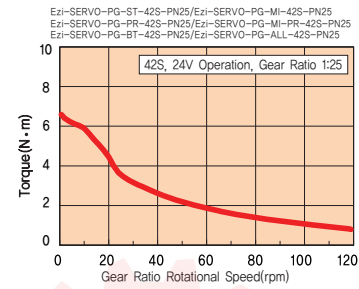
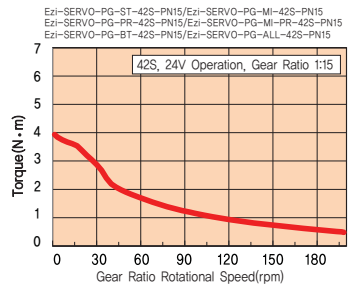
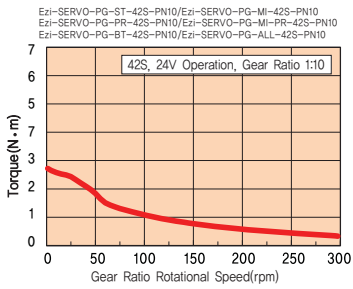
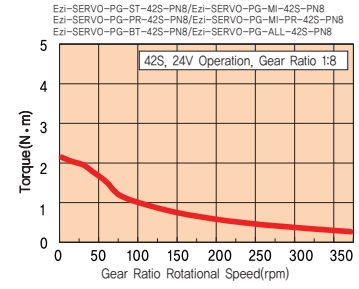
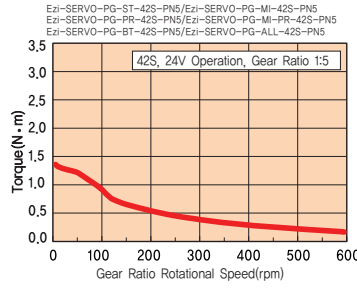
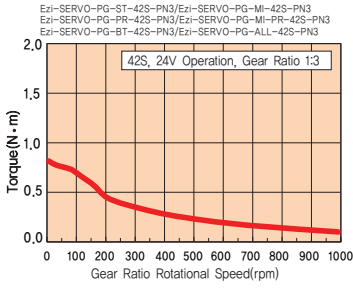

پرسی، انتخاب و فرید آنلاین موتور

Ezi-SERVO PG Series Rotational Speed – Torque Specifications (Motor Size 42mm)

Measurement Conditions : Motor Voltage = DC24V, Motor Current = Rated Current 1,2A

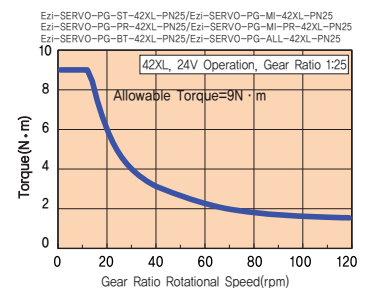
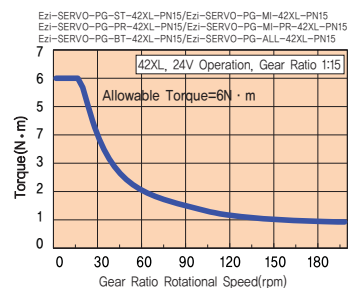
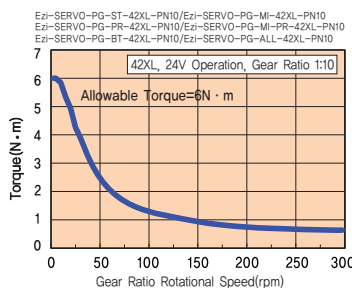
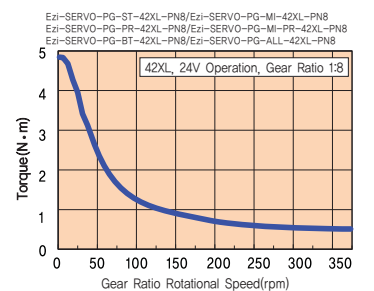
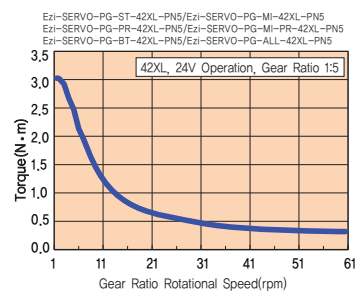
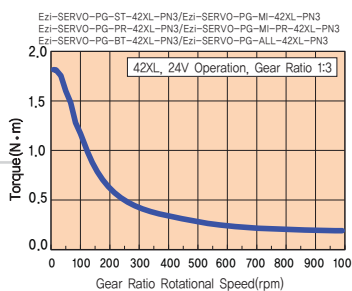
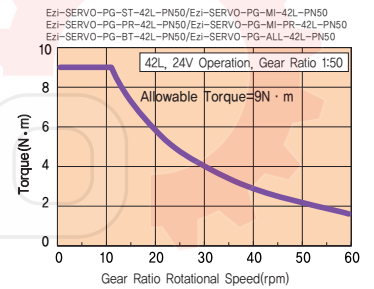
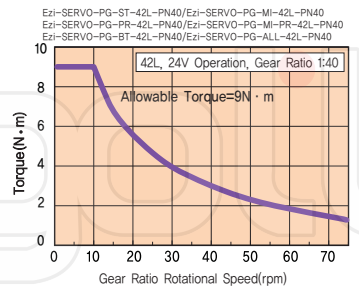
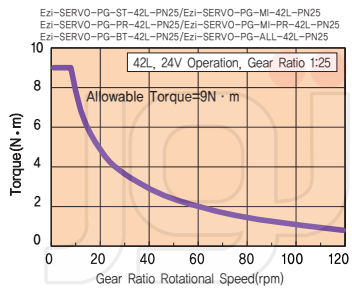
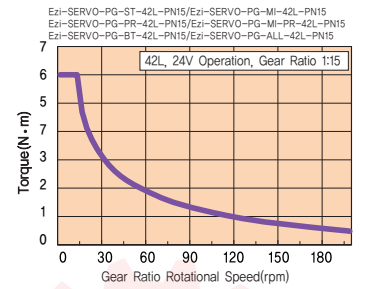
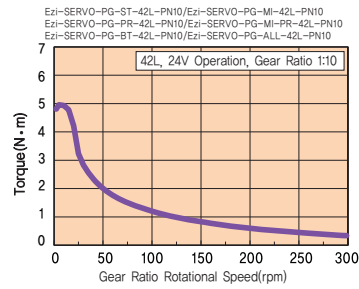
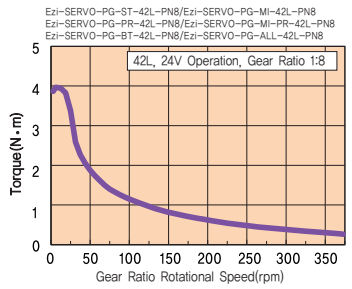
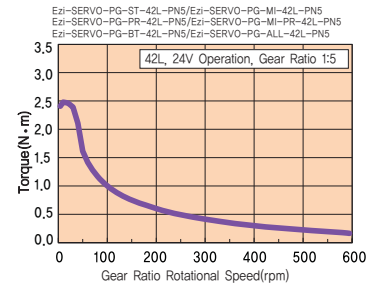
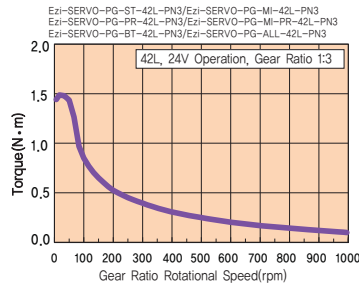
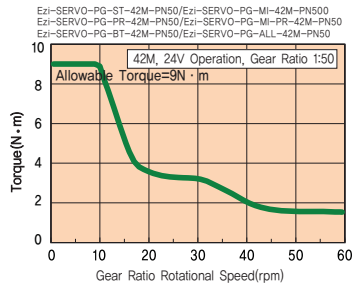

● Ezi-SERVO PG Series Rotational Speed – Torque Specifications (Motor Size 42mm)

Measurement Conditions : Motor Voltage = DC24V, Motor Current = Rated Current 1.2A

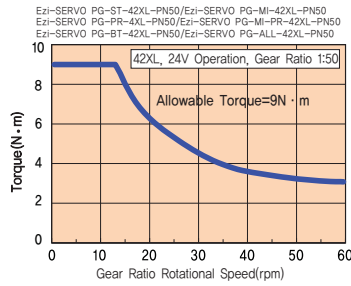
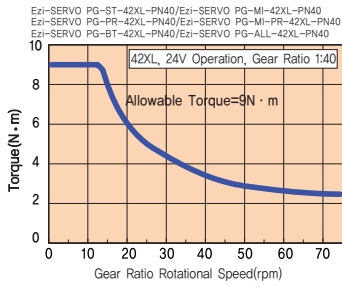

● Ezi-SERVO PG Series Rotational Speed – Torque Specifications (Motor Size 56mm)

Measurement Conditions : Motor Voltage = DC24V, Motor Current = Rated Current 3A

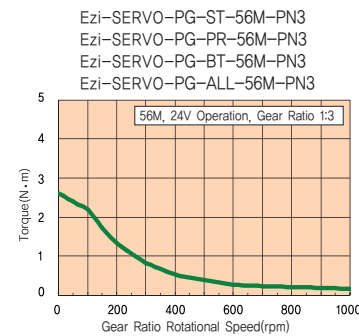
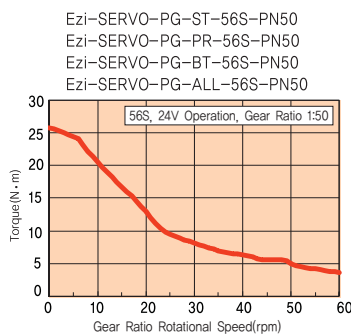
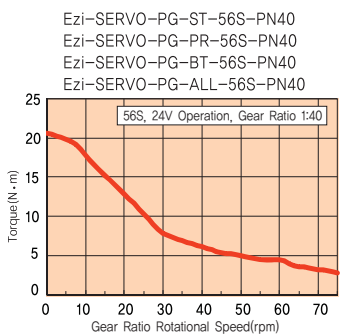
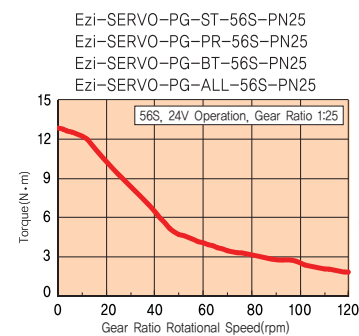
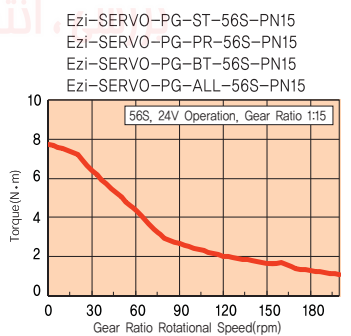
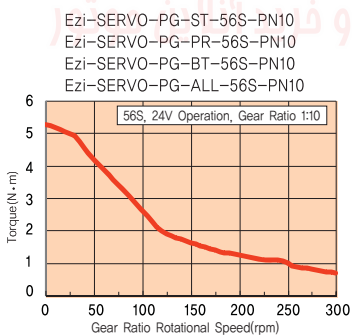
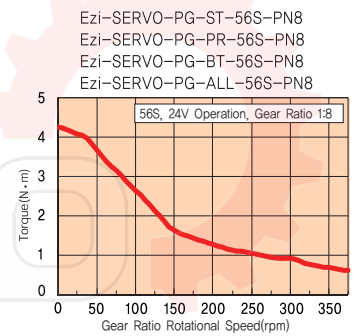
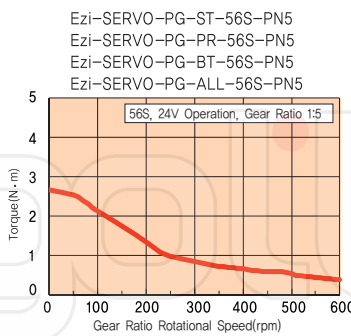
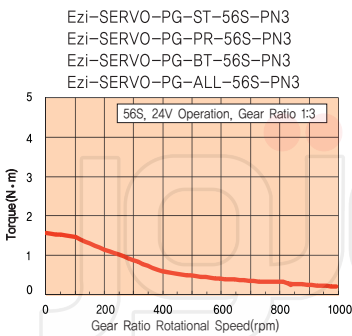

Ezi-SERVO PG Series Rotational Speed - Torque Specifications (Motor Size 56mm)

Measurement Conditions : Motor Voltage = DC24V, Motor Current = Rated Current 3A

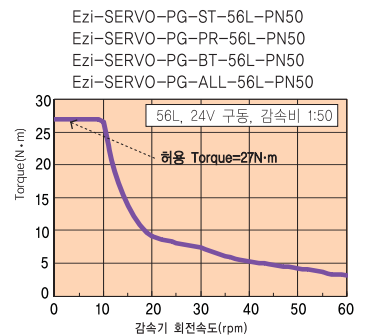
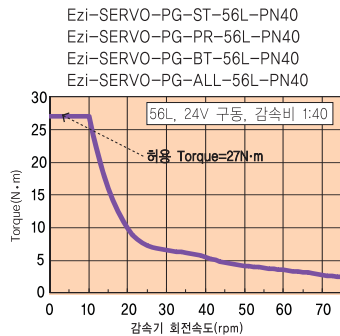
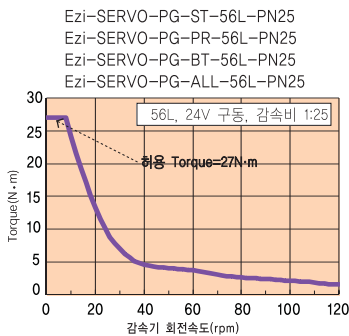
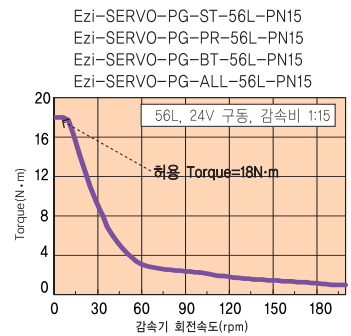
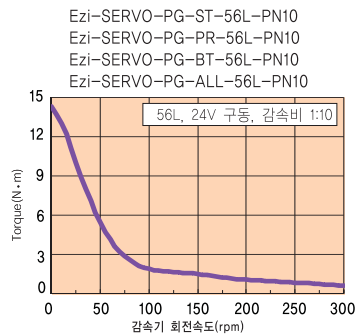
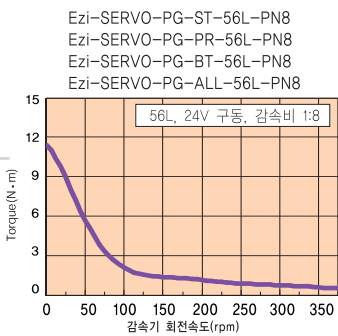
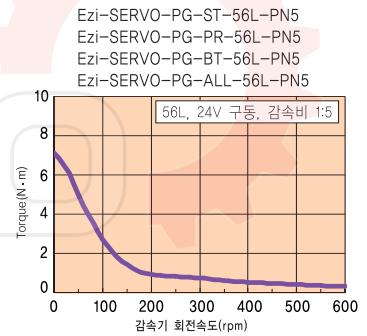
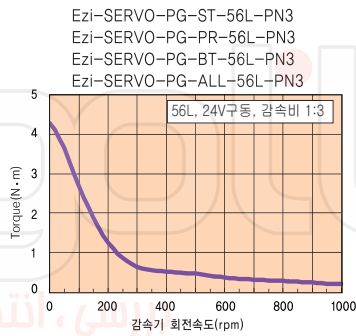
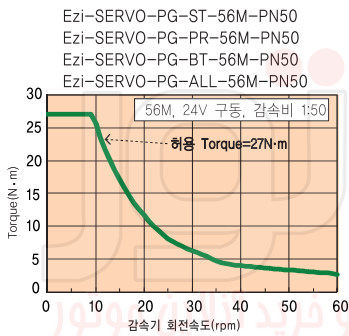
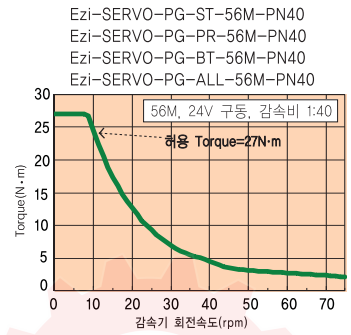
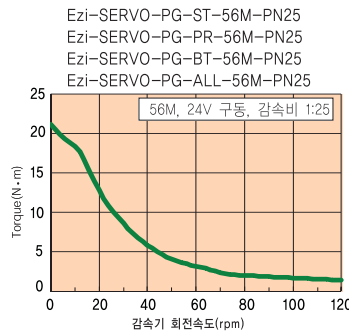
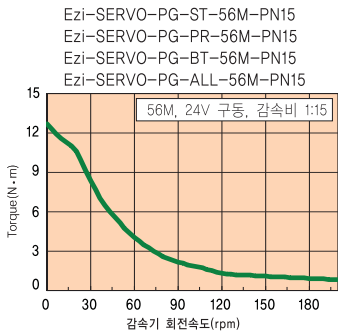
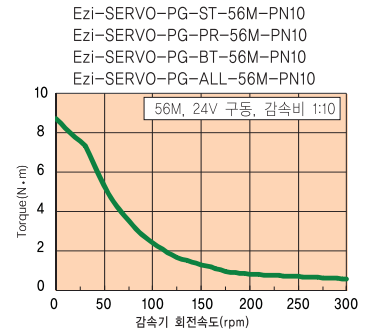
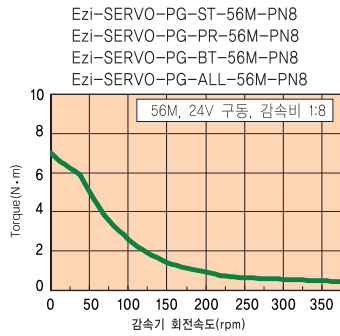
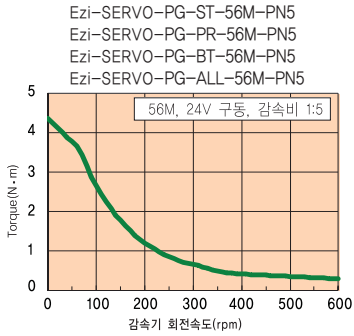

● Ezi-SERVO PG Series Rotational Speed – Torque Specifications (Motor Size 60mm)

Measurement Conditions : Motor Voltage = DC24V, Motor Current = Rated Current 4A

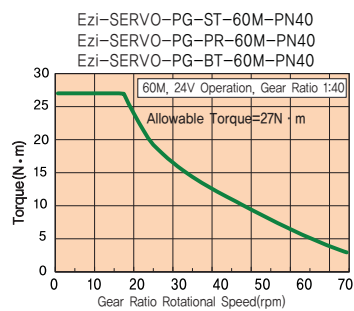
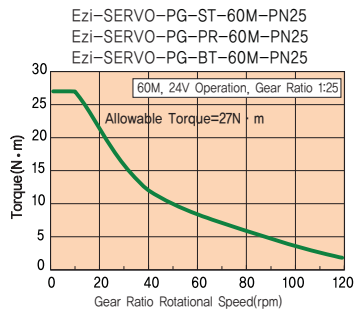
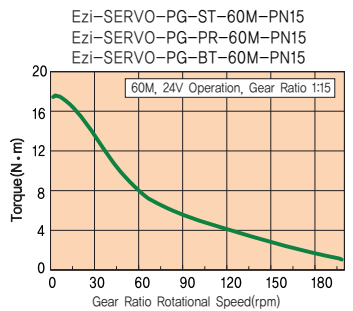
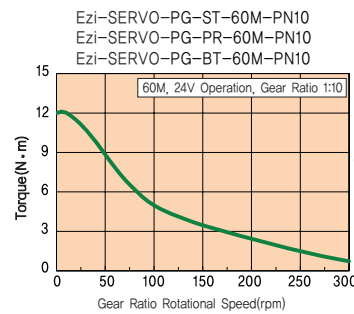
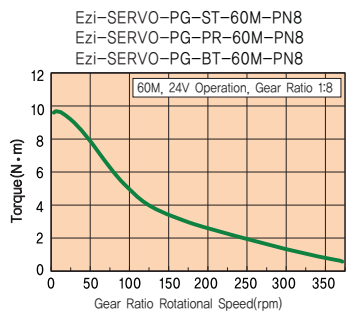
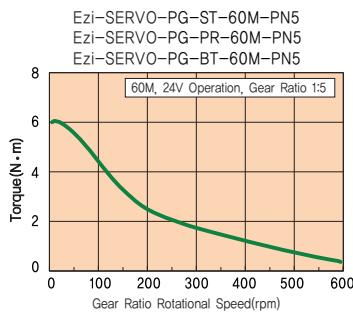
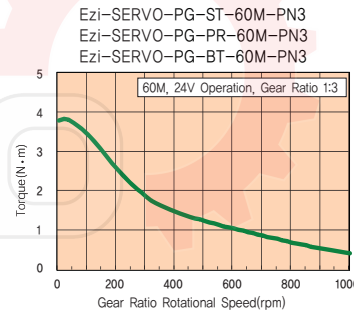
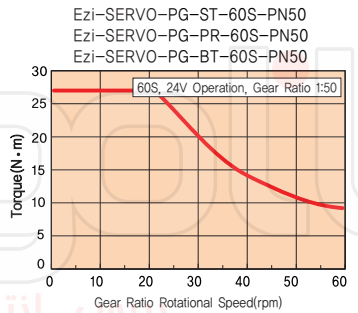
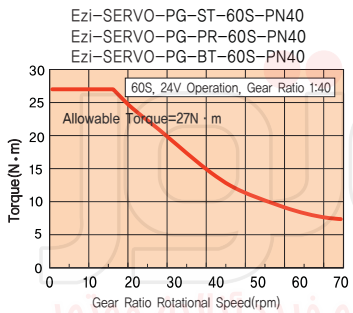
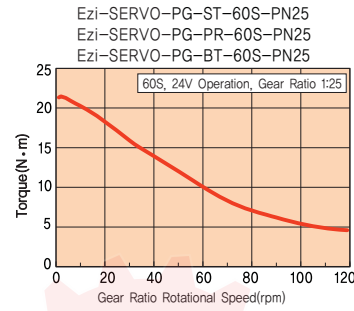
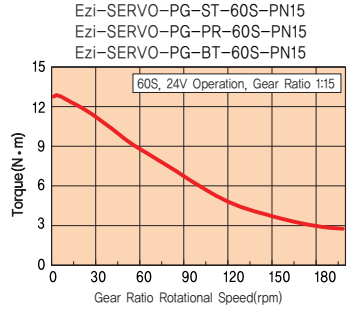
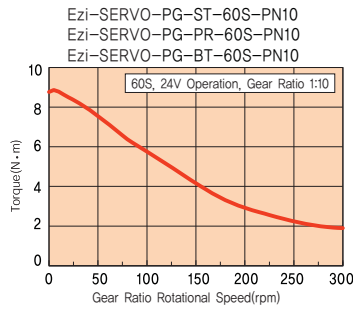
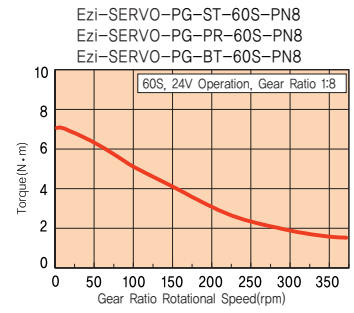
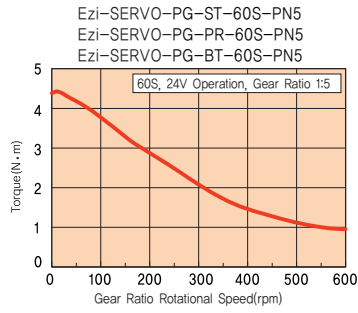
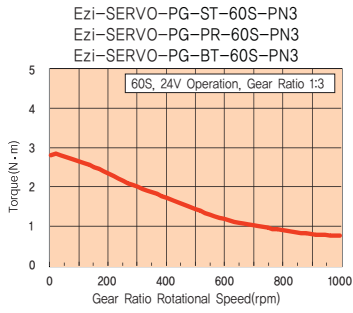

● Ezi-SERVO PG Series Rotational Speed – Torque Specifications (Motor Size 60mm)

Measurement Conditions : Motor Voltage = DC24V, Motor Current = Rated Current 4A

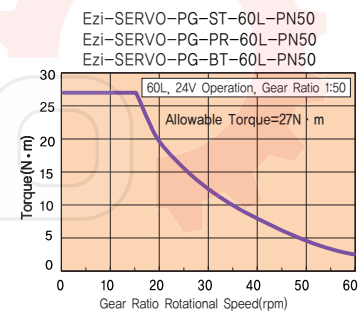
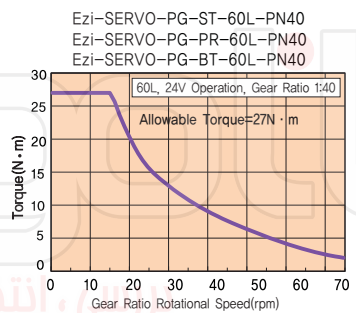
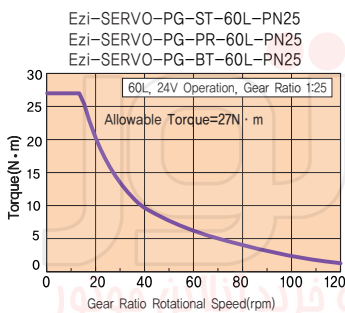
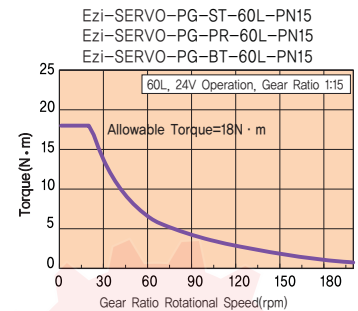
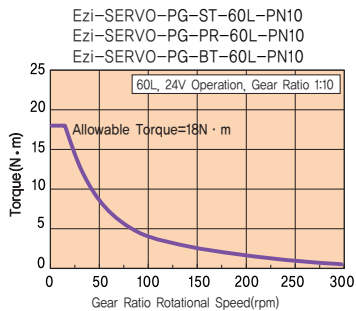
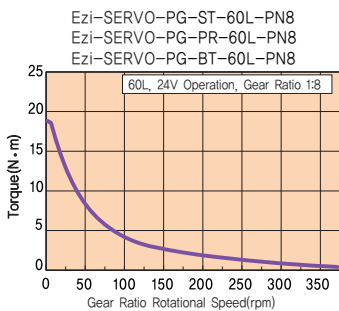
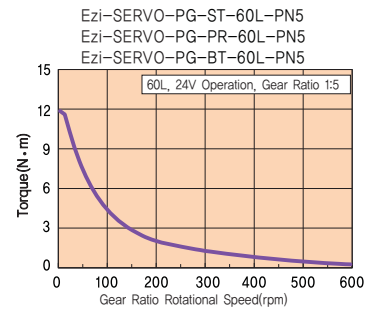
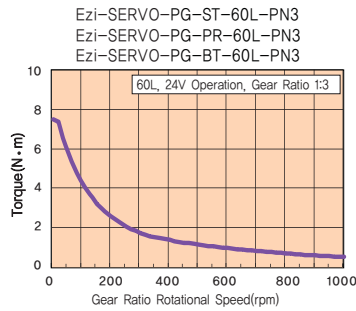
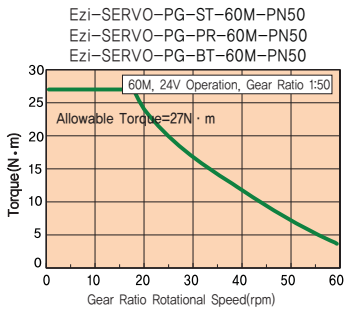

● Ezi-SERVO PG Series Allowable Overhung Load and Allowable Thrust Load

Part Name	Allowable Overhung Load (N)	Allowable Thrust Load (N)
	Based on Center of Shaft	
Ezi-SERVO-PG-ST-42S-PN3 Ezi-SERVO-PG-PR-42S-PN3 Ezi-SERVO-PG-BT-42S-PN3 Ezi-SERVO-PG-ALL-42S-PN3 Ezi-SERVO-PG-ST-42M-PN3 Ezi-SERVO-PG-PR-42M-PN3 Ezi-SERVO-PG-BT-42M-PN3 Ezi-SERVO-PG-ALL-42M-PN3 Ezi-SERVO-PG-ST-42L-PN3 Ezi-SERVO-PG-PR-42L-PN3 Ezi-SERVO-PG-BT-42L-PN3 Ezi-SERVO-PG-ALL-42L-PN3 Ezi-SERVO-PG-ST-42XL-PN3 Ezi-SERVO-PG-PR-42XL-PN3 Ezi-SERVO-PG-BT-42XL-PN3 Ezi-SERVO-PG-ALL-42XL-PN3	240	270
Ezi-SERVO-PG-ST-42S-PN5 Ezi-SERVO-PG-PR-42S-PN5 Ezi-SERVO-PG-BT-42S-PN5 Ezi-SERVO-PG-ALL-42S-PN5 Ezi-SERVO-PG-ST-42M-PN5 Ezi-SERVO-PG-PR-42M-PN5 Ezi-SERVO-PG-BT-42M-PN5 Ezi-SERVO-PG-ALL-42M-PN5 Ezi-SERVO-PG-ST-42L-PN5 Ezi-SERVO-PG-PR-42L-PN5 Ezi-SERVO-PG-BT-42L-PN5 Ezi-SERVO-PG-ALL-42L-PN5 Ezi-SERVO-PG-ST-42XL-PN5 Ezi-SERVO-PG-PR-42XL-PN5 Ezi-SERVO-PG-BT-42XL-PN5 Ezi-SERVO-PG-ALL-42XL-PN5	290	330
Ezi-SERVO-PG-ST-42S-PN8 Ezi-SERVO-PG-PR-42S-PN8 Ezi-SERVO-PG-BT-42S-PN8 Ezi-SERVO-PG-ALL-42S-PN8 Ezi-SERVO-PG-ST-42M-PN8 Ezi-SERVO-PG-PR-42M-PN8 Ezi-SERVO-PG-BT-42M-PN8 Ezi-SERVO-PG-ALL-42M-PN8 Ezi-SERVO-PG-ST-42L-PN8 Ezi-SERVO-PG-PR-42L-PN8 Ezi-SERVO-PG-BT-42L-PN8 Ezi-SERVO-PG-ALL-42L-PN8 Ezi-SERVO-PG-ST-42XL-PN8 Ezi-SERVO-PG-PR-42XL-PN8 Ezi-SERVO-PG-BT-42XL-PN8 Ezi-SERVO-PG-ALL-42XL-PN8	340	410
Ezi-SERVO-PG-ST-42S-PN10 Ezi-SERVO-PG-PR-42S-PN10 Ezi-SERVO-PG-BT-42S-PN10 Ezi-SERVO-PG-ALL-42S-PN10 Ezi-SERVO-PG-ST-42M-PN10 Ezi-SERVO-PG-PR-42M-PN10 Ezi-SERVO-PG-BT-42M-PN10 Ezi-SERVO-PG-ALL-42M-PN10 Ezi-SERVO-PG-ST-42L-PN10 Ezi-SERVO-PG-PR-42L-PN10 Ezi-SERVO-PG-BT-42L-PN10 Ezi-SERVO-PG-ALL-42L-PN10 Ezi-SERVO-PG-ST-42XL-PN10 Ezi-SERVO-PG-PR-42XL-PN10 Ezi-SERVO-PG-BT-42XL-PN10 Ezi-SERVO-PG-ALL-42XL-PN10	360	450
Ezi-SERVO-PG-ST-42S-PN15 Ezi-SERVO-PG-PR-42S-PN15 Ezi-SERVO-PG-BT-42S-PN15 Ezi-SERVO-PG-ALL-42S-PN15 Ezi-SERVO-PG-ST-42M-PN15 Ezi-SERVO-PG-PR-42M-PN15 Ezi-SERVO-PG-BT-42M-PN15 Ezi-SERVO-PG-ALL-42M-PN15 Ezi-SERVO-PG-ST-42L-PN15 Ezi-SERVO-PG-PR-42L-PN15 Ezi-SERVO-PG-BT-42L-PN15 Ezi-SERVO-PG-ALL-42L-PN15 Ezi-SERVO-PG-ST-42XL-PN15 Ezi-SERVO-PG-PR-42XL-PN15 Ezi-SERVO-PG-BT-42XL-PN15 Ezi-SERVO-PG-ALL-42XL-PN15	410	540

Part Name	Allowable Overhung Load (N)	Allowable Thrust Load (N)
	Based on Center of Shaft	
Ezi-SERVO-PG-ST-42S-PN25 Ezi-SERVO-PG-PR-42S-PN25 Ezi-SERVO-PG-BT-42S-PN25 Ezi-SERVO-PG-ALL-42S-PN25 Ezi-SERVO-PG-ST-42M-PN25 Ezi-SERVO-PG-PR-42M-PN25 Ezi-SERVO-PG-BT-42M-PN25 Ezi-SERVO-PG-ALL-42M-PN25 Ezi-SERVO-PG-ST-42L-PN25 Ezi-SERVO-PG-PR-42L-PN25 Ezi-SERVO-PG-BT-42L-PN25 Ezi-SERVO-PG-ALL-42L-PN25 Ezi-SERVO-PG-ST-42XL-PN25 Ezi-SERVO-PG-PR-42XL-PN25 Ezi-SERVO-PG-BT-42XL-PN25 Ezi-SERVO-PG-ALL-42XL-PN25	490	640
Ezi-SERVO-PG-ST-42S-PN40 Ezi-SERVO-PG-PR-42S-PN40 Ezi-SERVO-PG-BT-42S-PN40 Ezi-SERVO-PG-ALL-42S-PN40 Ezi-SERVO-PG-ST-42M-PN40 Ezi-SERVO-PG-PR-42M-PN40 Ezi-SERVO-PG-BT-42M-PN40 Ezi-SERVO-PG-ALL-42M-PN40 Ezi-SERVO-PG-ST-42L-PN40 Ezi-SERVO-PG-PR-42L-PN40 Ezi-SERVO-PG-BT-42L-PN40 Ezi-SERVO-PG-ALL-42L-PN40 Ezi-SERVO-PG-ST-42XL-PN40 Ezi-SERVO-PG-PR-42XL-PN40 Ezi-SERVO-PG-BT-42XL-PN40 Ezi-SERVO-PG-ALL-42XL-PN40	570	640
Ezi-SERVO-PG-ST-42S-PN50 Ezi-SERVO-PG-PR-42S-PN50 Ezi-SERVO-PG-BT-42S-PN50 Ezi-SERVO-PG-ALL-42S-PN50 Ezi-SERVO-PG-ST-42M-PN50 Ezi-SERVO-PG-PR-42M-PN50 Ezi-SERVO-PG-BT-42M-PN50 Ezi-SERVO-PG-ALL-42M-PN50 Ezi-SERVO-PG-ST-42L-PN50 Ezi-SERVO-PG-PR-42L-PN50 Ezi-SERVO-PG-BT-42L-PN50 Ezi-SERVO-PG-ALL-42L-PN50 Ezi-SERVO-PG-ST-42XL-PN50 Ezi-SERVO-PG-PR-42XL-PN50 Ezi-SERVO-PG-BT-42XL-PN50 Ezi-SERVO-PG-ALL-42XL-PN50	620	640

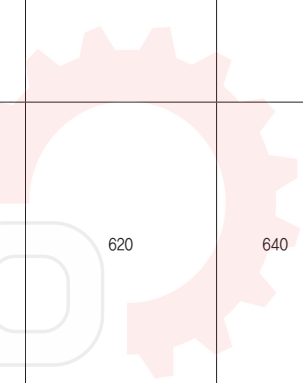
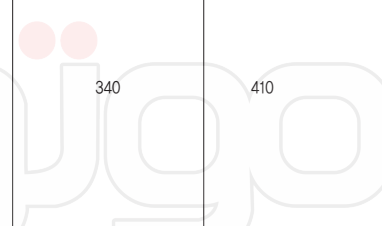

● Ezi-SERVO PG Series Allowable Overhung Load and Allowable Thrust Load

Part Name		Allowable Overhung Load (N) Based on Center of Shaft	Allowable Thrust Load (N)
Ezi-SERVO-PG-ST-56S-PN3 Ezi-SERVO-PG-PR-56S-PN3 Ezi-SERVO-PG-BT-56S-PN3 Ezi-SERVO-PG-ALL-56S-PN3 Ezi-SERVO-PG-ST-56M-PN3 Ezi-SERVO-PG-PR-56M-PN3 Ezi-SERVO-PG-BT-56M-PN3 Ezi-SERVO-PG-ALL-56M-PN3 Ezi-SERVO-PG-ST-56L-PN3 Ezi-SERVO-PG-PR-56L-PN3 Ezi-SERVO-PG-BT-56L-PN3 Ezi-SERVO-PG-ALL-56L-PN3	Ezi-SERVO-PG-ST-60S-PN3 Ezi-SERVO-PG-PR-60S-PN3 Ezi-SERVO-PG-BT-60S-PN3 Ezi-SERVO-PG-ST-60M-PN3 Ezi-SERVO-PG-PR-60M-PN3 Ezi-SERVO-PG-BT-60M-PN3 Ezi-SERVO-PG-ST-60L-PN3 Ezi-SERVO-PG-PR-60L-PN3 Ezi-SERVO-PG-BT-60L-PN3	430	310
Ezi-SERVO-PG-ST-56S-PN5 Ezi-SERVO-PG-PR-56S-PN5 Ezi-SERVO-PG-BT-56S-PN5 Ezi-SERVO-PG-ALL-56S-PN5 Ezi-SERVO-PG-ST-56M-PN5 Ezi-SERVO-PG-PR-56M-PN5 Ezi-SERVO-PG-BT-56M-PN5 Ezi-SERVO-PG-ALL-56M-PN5 Ezi-SERVO-PG-ST-56L-PN5 Ezi-SERVO-PG-PR-56L-PN5 Ezi-SERVO-PG-BT-56L-PN5 Ezi-SERVO-PG-ALL-56L-PN5	Ezi-SERVO-PG-ST-60S-PN5 Ezi-SERVO-PG-PR-60S-PN5 Ezi-SERVO-PG-BT-60S-PN5 Ezi-SERVO-PG-ST-60M-PN5 Ezi-SERVO-PG-PR-60M-PN5 Ezi-SERVO-PG-BT-60M-PN5 Ezi-SERVO-PG-ST-60L-PN5 Ezi-SERVO-PG-PR-60L-PN5 Ezi-SERVO-PG-BT-60L-PN5	510	390
Ezi-SERVO-PG-ST-56S-PN8 Ezi-SERVO-PG-PR-56S-PN8 Ezi-SERVO-PG-BT-56S-PN8 Ezi-SERVO-PG-ALL-56S-PN8 Ezi-SERVO-PG-ST-56M-PN8 Ezi-SERVO-PG-PR-56M-PN8 Ezi-SERVO-PG-BT-56M-PN8 Ezi-SERVO-PG-ALL-56M-PN8 Ezi-SERVO-PG-ST-56L-PN8 Ezi-SERVO-PG-PR-56L-PN8 Ezi-SERVO-PG-BT-56L-PN8 Ezi-SERVO-PG-ALL-56L-PN8	Ezi-SERVO-PG-ST-60S-PN8 Ezi-SERVO-PG-PR-60S-PN8 Ezi-SERVO-PG-BT-60S-PN8 Ezi-SERVO-PG-ST-60M-PN8 Ezi-SERVO-PG-PR-60M-PN8 Ezi-SERVO-PG-BT-60M-PN8 Ezi-SERVO-PG-ST-60L-PN8 Ezi-SERVO-PG-PR-60L-PN8 Ezi-SERVO-PG-BT-60L-PN8	600	480
Ezi-SERVO-PG-ST-56S-PN10 Ezi-SERVO-PG-PR-56S-PN10 Ezi-SERVO-PG-BT-56S-PN10 Ezi-SERVO-PG-ALL-56S-PN10 Ezi-SERVO-PG-ST-56M-PN10 Ezi-SERVO-PG-PR-56M-PN10 Ezi-SERVO-PG-BT-56M-PN10 Ezi-SERVO-PG-ALL-56M-PN10 Ezi-SERVO-PG-ST-56L-PN10 Ezi-SERVO-PG-PR-56L-PN10 Ezi-SERVO-PG-BT-56L-PN10 Ezi-SERVO-PG-ALL-56L-PN10	Ezi-SERVO-PG-ST-60S-PN10 Ezi-SERVO-PG-PR-60S-PN10 Ezi-SERVO-PG-BT-60S-PN10 Ezi-SERVO-PG-ST-60M-PN10 Ezi-SERVO-PG-PR-60M-PN10 Ezi-SERVO-PG-BT-60M-PN10 Ezi-SERVO-PG-ST-60L-PN10 Ezi-SERVO-PG-PR-60L-PN10 Ezi-SERVO-PG-BT-60L-PN10	640	530
Ezi-SERVO-PG-ST-56S-PN15 Ezi-SERVO-PG-PR-56S-PN15 Ezi-SERVO-PG-BT-56S-PN15 Ezi-SERVO-PG-ALL-56S-PN15 Ezi-SERVO-PG-ST-56M-PN15 Ezi-SERVO-PG-PR-56M-PN15 Ezi-SERVO-PG-BT-56M-PN15 Ezi-SERVO-PG-ALL-56M-PN15 Ezi-SERVO-PG-ST-56L-PN15 Ezi-SERVO-PG-PR-56L-PN15 Ezi-SERVO-PG-BT-56L-PN15 Ezi-SERVO-PG-ALL-56L-PN15	Ezi-SERVO-PG-ST-60S-PN15 Ezi-SERVO-PG-PR-60S-PN15 Ezi-SERVO-PG-BT-60S-PN15 Ezi-SERVO-PG-ST-60M-PN15 Ezi-SERVO-PG-PR-60M-PN15 Ezi-SERVO-PG-BT-60M-PN15 Ezi-SERVO-PG-ST-60L-PN15 Ezi-SERVO-PG-PR-60L-PN15 Ezi-SERVO-PG-BT-60L-PN15	740	630
Ezi-SERVO-PG-ST-56S-PN25 Ezi-SERVO-PG-PR-56S-PN25 Ezi-SERVO-PG-BT-56S-PN25 Ezi-SERVO-PG-ALL-56S-PN25 Ezi-SERVO-PG-ST-56M-PN25 Ezi-SERVO-PG-PR-56M-PN25 Ezi-SERVO-PG-BT-56M-PN25 Ezi-SERVO-PG-ALL-56M-PN25 Ezi-SERVO-PG-ST-56L-PN25 Ezi-SERVO-PG-PR-56L-PN25 Ezi-SERVO-PG-BT-56L-PN25 Ezi-SERVO-PG-ALL-56L-PN25	Ezi-SERVO-PG-ST-60S-PN25 Ezi-SERVO-PG-PR-60S-PN25 Ezi-SERVO-PG-BT-60S-PN25 Ezi-SERVO-PG-ST-60M-PN25 Ezi-SERVO-PG-PR-60M-PN25 Ezi-SERVO-PG-BT-60M-PN25 Ezi-SERVO-PG-ST-60L-PN25 Ezi-SERVO-PG-PR-60L-PN25 Ezi-SERVO-PG-BT-60L-PN25	870	790
Ezi-SERVO-PG-ST-56S-PN40 Ezi-SERVO-PG-PR-56S-PN40 Ezi-SERVO-PG-BT-56S-PN40 Ezi-SERVO-PG-ALL-56S-PN40 Ezi-SERVO-PG-ST-56M-PN40 Ezi-SERVO-PG-PR-56M-PN40 Ezi-SERVO-PG-BT-56M-PN40 Ezi-SERVO-PG-ALL-56M-PN40 Ezi-SERVO-PG-ST-56L-PN40 Ezi-SERVO-PG-PR-56L-PN40 Ezi-SERVO-PG-BT-56L-PN40 Ezi-SERVO-PG-ALL-56L-PN40	Ezi-SERVO-PG-ST-60S-PN40 Ezi-SERVO-PG-PR-60S-PN40 Ezi-SERVO-PG-BT-60S-PN40 Ezi-SERVO-PG-ST-60M-PN40 Ezi-SERVO-PG-PR-60M-PN40 Ezi-SERVO-PG-BT-60M-PN40 Ezi-SERVO-PG-ST-60L-PN40 Ezi-SERVO-PG-PR-60L-PN40 Ezi-SERVO-PG-BT-60L-PN40	1000	970
Ezi-SERVO-PG-ST-56S-PN50 Ezi-SERVO-PG-PR-56S-PN50 Ezi-SERVO-PG-BT-56S-PN50 Ezi-SERVO-PG-ALL-56S-PN50 Ezi-SERVO-PG-ST-56M-PN50 Ezi-SERVO-PG-PR-56M-PN50 Ezi-SERVO-PG-BT-56M-PN50 Ezi-SERVO-PG-ALL-56M-PN50 Ezi-SERVO-PG-ST-56L-PN50 Ezi-SERVO-PG-PR-56L-PN50 Ezi-SERVO-PG-BT-56L-PN50 Ezi-SERVO-PG-ALL-56L-PN50	Ezi-SERVO-PG-ST-60S-PN50 Ezi-SERVO-PG-PR-60S-PN50 Ezi-SERVO-PG-BT-60S-PN50 Ezi-SERVO-PG-ST-60M-PN50 Ezi-SERVO-PG-PR-60M-PN50 Ezi-SERVO-PG-BT-60M-PN50 Ezi-SERVO-PG-ST-60L-PN50 Ezi-SERVO-PG-PR-60L-PN50 Ezi-SERVO-PG-BT-60L-PN50	1100	1000

Part Name		Allowable Overhung Load (N) Based on Center of Shaft	Allowable Thrust Load (N)
Ezi-SERVO-PG-ST-86M-PN3 Ezi-SERVO-PG-PR-86M-PN3 Ezi-SERVO-PG-ST-86L-PN3 Ezi-SERVO-PG-PR-86L-PN3 Ezi-SERVO-PG-ST-86XL-PN3 Ezi-SERVO-PG-PR-86XL-PN3		810	930
Ezi-SERVO-PG-ST-86M-PN5 Ezi-SERVO-PG-PR-86M-PN5 Ezi-SERVO-PG-ST-86L-PN5 Ezi-SERVO-PG-PR-86L-PN5 Ezi-SERVO-PG-ST-86XL-PN5 Ezi-SERVO-PG-PR-86XL-PN5		960	1200
Ezi-SERVO-PG-ST-86M-PN8 Ezi-SERVO-PG-PR-86M-PN8 Ezi-SERVO-PG-ST-86L-PN8 Ezi-SERVO-PG-PR-86L-PN8 Ezi-SERVO-PG-ST-86XL-PN8 Ezi-SERVO-PG-PR-86XL-PN8		1100	1400
Ezi-SERVO-PG-ST-86M-PN10 Ezi-SERVO-PG-PR-86M-PN10 Ezi-SERVO-PG-ST-86L-PN10 Ezi-SERVO-PG-PR-86L-PN10 Ezi-SERVO-PG-ST-86XL-PN10 Ezi-SERVO-PG-PR-86XL-PN10		1200	1600
Ezi-SERVO-PG-ST-86M-PN15 Ezi-SERVO-PG-PR-86M-PN15 Ezi-SERVO-PG-ST-86L-PN15 Ezi-SERVO-PG-PR-86L-PN15 Ezi-SERVO-PG-ST-86XL-PN15 Ezi-SERVO-PG-PR-86XL-PN15		1200	1900
Ezi-SERVO-PG-ST-86M-PN25 Ezi-SERVO-PG-PR-86M-PN25 Ezi-SERVO-PG-ST-86L-PN25 Ezi-SERVO-PG-PR-86L-PN25 Ezi-SERVO-PG-ST-86XL-PN25 Ezi-SERVO-PG-PR-86XL-PN25		1600	2200
Ezi-SERVO-PG-ST-86M-PN40 Ezi-SERVO-PG-PR-86M-PN40 Ezi-SERVO-PG-ST-86L-PN40 Ezi-SERVO-PG-PR-86L-PN40 Ezi-SERVO-PG-ST-86XL-PN40 Ezi-SERVO-PG-PR-86XL-PN40		1900	2200
Ezi-SERVO-PG-ST-86M-PN50 Ezi-SERVO-PG-PR-86M-PN50 Ezi-SERVO-PG-ST-86L-PN50 Ezi-SERVO-PG-PR-86L-PN50 Ezi-SERVO-PG-ST-86XL-PN50 Ezi-SERVO-PG-PR-86XL-PN50		2100	2200

● Drive Specification and Size

Please refer to the individual catalogue (Ezi-SERVO ST, Ezi-SERVO Plus R, Ezi-SERVO BT and Ezi-SERVO ALL) to check drive specification and size of Ezi-SERVO ST/PR/BT/ALL of Ezi-SERVO PG Series

● System Configuration and Setting/Operation

Please refer to the individual catalogue (Ezi-SERVO ST, Ezi-SERVO Plus R, Ezi-SERVO BT and Ezi-SERVO ALL) to check Series' system configuration, setting and operation of Ezi-SERVO ST/PR/BT/ALL of Ezi-SERVO PG Series.

● External Wiring Diagram

Please refer to the individual catalogue (Ezi-SERVO ST, Ezi-SERVO Plus R, Ezi-SERVO BT and Ezi-SERVO ALL) to check Series' external wiring diagram of Ezi-SERVO ST/PR/BT/ALL of Ezi-SERVO PG Series.



MEMO



MEMO





Fast, Accurate, Smooth Motion

FASTECH Co., Ltd.

Rm #1202, Bucheon Technopark 401 Dong, Yakdea-dong,
Wonmi-Gu, Bucheon-si, Gyeonggi-do, Rep. Of Korea (Zip)420-734
TEL : 82-32-234-6300,6301 FAX : 82-32-234-6302
E-mail : fastech@fastech.co.kr Homepage : www.fastech.co.kr

FASTECH AMERICA LLC

811 E Plano Parkway, Suite 110A, Plano, TX 75074 USA
Toll Free: 877-905-4428 972-218-0210
Email: support@fastechamerica.com
website: www.fastechamerica.com