

User's Manual

For

3DM683

Fully Digital Three Phase Stepping Driver

Version 1.0

©2009 All Rights Reserved

Attention: Please read this manual carefully before using the driver!



The content in this manual has been carefully prepared and is believed to be accurate, but no responsibility is assumed for inaccuracies.

Leadshine reserves the right to make changes without further notice to any products herein to improve reliability, function or design. Leadshine does not assume any liability arising out of the application or use of any product or circuit described herein; neither does it convey any license under its patent rights of others.

Leadshine's general policy does not recommend the use of its products in life support or aircraft applications wherein a failure or malfunction of the product may directly threaten life or injury. According to Leadshine's terms and conditions of sales, the user of Leadshine's products in life support or aircraft applications assumes all risks of such use and indemnifies Leadshine against all damages.



Leadshine Technology Co., Ltd.

3/F, Block 2, Nanyou Tianan Industrial Park, Nanshan Dist, Shenzhen, China

T: (86)755-26434369

F: (86)755-26402718

Web site: www.leadshine.com

E-Mail: sales@leadshine.com

©2009 by Leadshine Technology Company Limited.
All Rights Reserved

Table of Contents

| | |
|---|----|
| 1. Introduction, Features and Applications | 1 |
| Introduction | 1 |
| Features | 1 |
| Applications | 1 |
| 2. Specifications | 2 |
| Electrical Specifications | 2 |
| Mechanical Specifications..... | 2 |
| Elimination of Heat | 2 |
| Operating Environment and other Specifications..... | 3 |
| 3. Pin Assignment and Description | 3 |
| Connector P1 Configurations | 3 |
| Selecting Active Pulse Edge and Control Signal Mode | 4 |
| Connector P2 Configurations | 4 |
| 4. Control Signal Connector (P1) Interface..... | 4 |
| 5. Connecting the Motor..... | 5 |
| 6. Power Supply Selection | 5 |
| Regulated or Unregulated Power Supply | 6 |
| Multiple Drivers | 6 |
| Selecting Supply Voltage..... | 6 |
| 7. Selecting Microstep Resolution and Driver Output Current | 6 |
| Microstep Resolution Selection | 7 |
| Current Settings..... | 8 |
| Dynamic current setting | 8 |
| Standstill current setting..... | 8 |
| 8. Wiring Notes | 9 |
| 9. Typical Connection..... | 9 |
| 10. Sequence Chart of Control Signals | 10 |
| 11. Protection Functions | 10 |
| Over-current Protection..... | 10 |

| | |
|--|----|
| Over-voltage Protection | 11 |
| Phase Error Protection..... | 11 |
| Protection Indications..... | 11 |
| 12. Frequently Asked Questions..... | 11 |
| Problem Symptoms and Possible Causes | 12 |
| 13. Professional Tuning Software ProTuner..... | 13 |
| Introduction | 13 |
| Software Installation | 13 |
| Connections and Testing | 13 |
| RS232 Interface Connection | 17 |
| Testing the Stepping System | 17 |
| Software Introduction..... | 18 |
| ProTuner Main Window | 18 |
| Com Config Window | 19 |
| Tuning | 19 |
| Anti-Resonance Introduction | 22 |
| Procedure for Achieving Optimum Performance..... | 23 |
| APPENDIX | 29 |
| Twelve Month Limited Warranty | 29 |
| Exclusions | 29 |
| Obtaining Warranty Service | 29 |
| Warranty Limitations..... | 29 |

1. Introduction, Features and Applications

Introduction

The 3DM683 is a versatility fully digital stepping driver based on a DSP with advanced control algorithm. The 3DM683 is the next generation of digital stepping motor controls. It brings a unique level of system smoothness, providing optimum torque and nulls mid-range instability. Motor self-test and parameter auto-setup technology offers optimum responses with different motors and easy-to-use. The driven motors can run with much smaller noise, lower heating, smoother movement than most of the drivers in the markets. Its unique features make the 3DM683 an ideal solution for applications that require low-speed smoothness.

Compared to the 3ND583, broader input voltage and output current ranges make the 3DM683 can drive much more motors than the 3ND583.

Features

- ┆ Anti-Resonance, provides optimum torque and nulls mid-range instability
- ┆ Motor self-test and parameter auto-setup technology, offers optimum responses with different motors
- ┆ Multi-Stepping allows a low resolution step input to produce a higher microstep output for smooth system performance
- ┆ Microstep resolutions programmable, from 200 to 102,400 steps/rev
- ┆ Supply voltage up to +60 VDC
- ┆ Output current programmable, from 0.5A to 8.3A
- ┆ Pulse input frequency up to 200 KHz
- ┆ TTL compatible and optically isolated input
- ┆ Automatic idle-current reduction
- ┆ Suitable for 3/6 leads Three-phase motors
- ┆ Support PUL/DIR and CW/CCW modes
- ┆ Over-voltage, over-current, phase-error protections

Applications

Suitable for a wide range of stepping motors, from NEMA frame size 17 to 34. It can be used in various kinds of machines, such as laser cutters, laser markers, high precision X-Y tables, labeling machines, and so on. Its unique features make the 3DM683 an ideal solution for applications that require both low-speed smoothness and high speed performances.

2. Specifications

Electrical Specifications ($T_j = 25^{\circ}\text{C}/77^{\circ}\text{F}$)

| Parameters | 3DM683 | | | Unit |
|-----------------------|--------|---------|---------------|------|
| | Min | Typical | Max | |
| Output current | 0.5 | - | 8.3 (5.9 RMS) | A |
| Supply voltage | +20 | - | +60 | VDC |
| Logic signal current | 7 | 10 | 16 | mA |
| Pulse input frequency | 0 | - | 200 | kHz |
| Isolation resistance | 500 | | | MΩ |

Mechanical Specifications (unit: mm [inch], 1 inch = 25.4 mm)

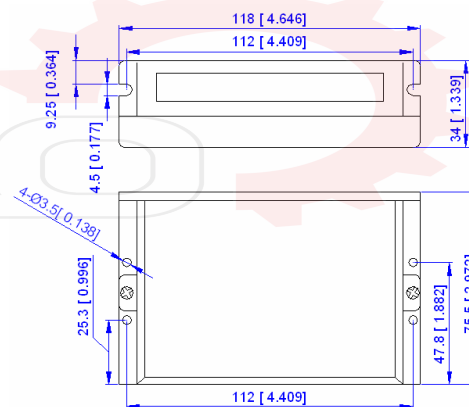

Figure 1: Mechanical specifications

Elimination of Heat

- ┆ Driver's reliable working temperature should be $<70^{\circ}\text{C}$ (158°F), and motor working temperature should be $<80^{\circ}\text{C}$ (176°F);
- ┆ It is recommended to use automatic idle-current mode, namely current automatically reduce to 60% when motor stops, so as to reduce driver heating and motor heating;
- ┆ It is recommended to mount the driver vertically to maximize heat sink area. Use forced cooling method to cool the system if necessary.

Operating Environment and other Specifications

| | | |
|-----------------------|-----------------------------------|---|
| Cooling | Natural Cooling or Forced cooling | |
| Operating Environment | Environment | Avoid dust, oil fog and corrosive gases |
| | Ambient Temperature | 0°C — 50°C (32°F — 122°F) |
| | Humidity | 40%RH — 90%RH |
| | Operating Temperature | 70°C (158°F) Max |
| | Vibration | 5.9m/s ² Max |
| Storage Temperature | -20°C — 65°C (-4°F — 149°F) | |
| Weight | Approx. 270g (9.5oz) | |

3. Pin Assignment and Description

The 3DM683 has two connectors, connector P1 for control signals connections, and connector P2 for power and motor connections. The following tables are brief descriptions of the two connectors. More detailed descriptions of the pins and related issues are presented in section 4, 5, 9.

Connector P1 Configurations

| Pin Function | Details |
|--------------|---|
| PUL+ | Pulse signal: In single pulse (pulse/direction) mode, this input represents pulse signal, each rising or falling edge active (software configurable); 4-5V when PUL-HIGH, 0-0.5V when PUL-LOW. In double pulse mode (pulse/pulse) , this input represents clockwise (CW) pulse, active both at high level and low level (software configurable). For reliable response, pulse width should be longer than 2.5μs. Series connect resistors for current-limiting when +12V or +24V used. The same as DIR and ENA signals. |
| PUL- | |
| DIR+ | DIR signal: In single-pulse mode, this signal has low/high voltage levels, representing two directions of motor rotation; in double-pulse mode (software configurable), this signal is counter-clock (CCW) pulse, active both at high level and low level (software configurable). For reliable motion response, DIR signal should be ahead of PUL signal by 5μs at least. 4-5V when DIR-HIGH, 0-0.5V when DIR-LOW. Please note that rotation direction is also related to motor-driver wiring match. Exchanging the connection of two wires for a coil to the driver will reverse motion direction. |
| DIR- | |
| ENA+ | Enable signal: This signal is used for enabling/disabling the driver. High level (NPN control signal, PNP and Differential control signals are on the contrary, namely Low level for enabling.) for enabling the driver and low level for disabling the driver. Usually left UNCONNECTED (ENABLED) . |
| ENA- | |

Selecting Active Pulse Edge and Control Signal Mode

The 3DM683 supports PUL/DIR and CW/CCW modes and pulse actives at rising or falling edge. See more information about these settings in Section 13. Default setting is PUL/DIR mode and rising edge active (NPN, and PNP control signal is on the contrary).

Connector P2 Configurations

| Pin Function | Details |
|--------------|---|
| GND | Power Ground |
| +Vdc | Power supply, 20~60 VDC, Including voltage fluctuation and EMF voltage. |
| U | Motor phase U |
| V | Motor phase V |
| W | Motor phase W |

4. Control Signal Connector (P1) Interface

The 3DM683 can accept differential and single-ended inputs (including open-collector and PNP output). The 3DM683 has 3 optically isolated logic inputs which are located on connector P1 to accept line driver control signals. These inputs are isolated to minimize or eliminate electrical noises coupled onto the drive control signals. Recommend use line driver control signals to increase noise immunity of the driver in interference environments. In the following figures, connections to open-collector and PNP signals are illustrated.

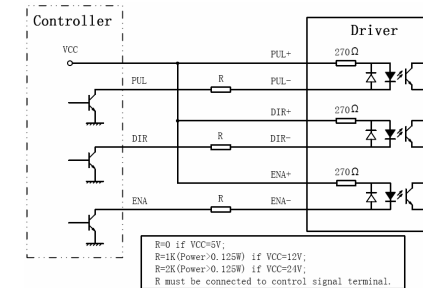

Figure 2: Connections to open-collector signal (common-anode)

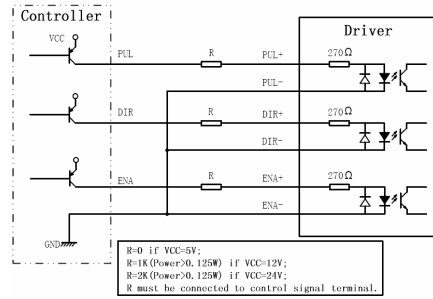

Figure 3: Connection to PNP signal (common-cathode)

5. Connecting the Motor

The 3DM683 can drive any 3 lead or 6 lead three phase hybrid stepping motors. The connection between the driver and 3-phase stepping motors includes two different kinds of connections, namely delta-connection and star-connection. Using delta-connection, the performances of the motor under high speed condition are better, but the driver current is higher too (about 1.73 times the motor coil current); while using star-connection, the driver current equals to the motor coil current.

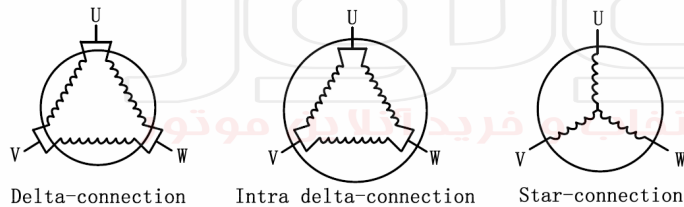

Figure 4: Motor connections

6. Power Supply Selection

The 3DM683 can match medium and small size stepping motors (from NEMA frame size 14 to 34) made by Leadshine or other motor manufactures around the world. To achieve good driving performances, it is important to select supply voltage and output current properly. Generally speaking, supply voltage determines the high speed performance of the motor, while output current determines the output torque of the driven motor (particularly at lower speed). Higher supply voltage will allow higher motor speed to be achieved, at the price of more noise and heating. If the motion speed requirement is low, it's better to use lower supply voltage to decrease noise, heating and improve

reliability.

Regulated or Unregulated Power Supply

Both regulated and unregulated power supplies can be used to supply the driver. However, unregulated power supplies are preferred due to their ability to withstand current surge. If regulated power supplies (such as most switching supplies.) are indeed used, it is important to have large current output rating to avoid problems like current clamp, for example using 4A supply for 3A motor-driver operation. On the other hand, if unregulated supply is used, one may use a power supply of lower current rating than that of motor (typically 50%~70% of motor current). The reason is that the driver draws current from the power supply capacitor of the unregulated supply only during the ON duration of the PWM cycle, but not during the OFF duration. Therefore, the average current withdrawn from power supply is considerably less than motor current. For example, two 3A motors can be well supplied by one power supply of 4A rating.

Multiple Drivers

It is recommended to have multiple drivers to share one power supply to reduce cost, if the supply has enough capacity. To avoid cross interference, **DO NOT** daisy-chain the power supply input pins of the drivers. Instead, please connect them to power supply separately.

Selecting Supply Voltage

The power MOSFETS inside the 3DM683 can actually operate within +20 ~ +60VDC, including power input fluctuation and back EMF voltage generated by motor coils during motor shaft deceleration. Higher supply voltage can increase motor torque at higher speeds, thus helpful for avoiding losing steps. However, higher voltage may cause bigger motor vibration at lower speed, and it may also cause over-voltage protection or even driver damage. Therefore, it is suggested to choose only sufficiently high supply voltage for intended applications, and it is suggested to use power supplies with theoretical output voltage of +20 ~ +54VDC, leaving room for power fluctuation and back-EMF.

7. Selecting Microstep Resolution and Driver Output Current

Microstep resolutions and output current are programmable, the former can be set from 200 to 102,400 steps/rev and the latter can be set from 0.5A to 8.3A. See more information about **Microstep Resolution and Output Current Setting** in Section 13.

However, when it's not in software configured mode, this driver uses an 8-bit DIP switch to set

microstep resolution, and motor operating current, as shown below:

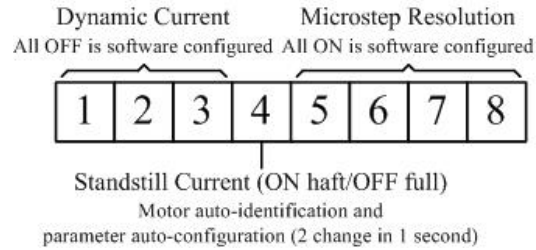

Microstep Resolution Selection

When it's not in software configured mode, microstep resolution is set by SW5, 6, 7, 8 of the DIP switch as shown in the following table:

| Steps/rev.(for 1.2°motor) | SW5 | SW6 | SW7 | SW8 |
|--|-----|-----|-----|-----|
| Default/Software configured, (From 200 to 102,400) | ON | ON | ON | ON |
| 400 | OFF | ON | ON | ON |
| 800 | ON | OFF | ON | ON |
| 1600 | OFF | OFF | ON | ON |
| 3200 | ON | ON | OFF | ON |
| 6400 | OFF | ON | OFF | ON |
| 12800 | ON | OFF | OFF | ON |
| 25600 | OFF | OFF | OFF | ON |
| 1000 | ON | ON | ON | OFF |
| 2000 | OFF | ON | ON | OFF |
| 4000 | ON | OFF | ON | OFF |
| 5000 | OFF | OFF | ON | OFF |
| 8000 | ON | ON | OFF | OFF |
| 10000 | OFF | ON | OFF | OFF |
| 20000 | ON | OFF | OFF | OFF |
| 25000 | OFF | OFF | OFF | OFF |

Current Settings

For a given motor, higher driver current will make the motor to output more torque, but at the same time causes more heating in the motor and driver. Therefore, output current is generally set to be such that the motor will not overheat for long time operation. Since parallel and serial connections of motor coils will significantly change resulting inductance and resistance, it is therefore important to set driver output current depending on motor phase current, motor leads and connection methods. Phase current rating supplied by motor manufacturer is important in selecting driver current, however the selection also depends on leads and connections.

When it's not in software configured mode, the first three bits (SW1, 2, 3) of the DIP switch are used to set the dynamic current. Select a setting closest to your motor's required current.

Dynamic current setting

| Peak Current | RMS Current | SW1 | SW2 | SW3 |
|---|-------------|-----|-----|-----|
| Default/Software configured (0.5 to 8.3A) | | OFF | OFF | OFF |
| 3.2A | 2.3A | ON | OFF | OFF |
| 4.0A | 2.9A | OFF | ON | OFF |
| 4.9A | 3.5A | ON | ON | OFF |
| 5.7A | 4.1A | OFF | OFF | ON |
| 6.4A | 4.6A | ON | OFF | ON |
| 7.3A | 5.2A | OFF | ON | ON |
| 8.3A | 5.9A | ON | ON | ON |

Notes: Due to motor inductance, the actual current in the coil may be smaller than the dynamic current setting, particularly under high speed condition.

Standstill current setting

SW4 is used for this purpose. OFF meaning that the standstill current is set to be half of the selected dynamic current, and ON meaning that standstill current is set to be the same as the selected dynamic current.

The current automatically reduced to 60% of the selected dynamic current one second after the last pulse. Theoretically, this will reduce motor heating to 36% (due to $P=I^2 \cdot R$) of the original value. If

the application needs a different standstill current, please contact Leadshine.

8. Wiring Notes

- I In order to improve anti-interference performance of the driver, it is recommended to use twisted pair shield cable.
- I To prevent noise incurred in PUL/DIR signal, pulse/direction signal wires and motor wires should not be tied up together. It is better to separate them by at least 10 cm, otherwise the disturbing signals generated by motor will easily disturb pulse direction signals, causing motor position error, system instability and other failures.
- I If a power supply serves several drivers, separately connecting the drivers is recommended instead of daisy-chaining.
- I It is prohibited to pull and plug connector P2 while the driver is powered ON, because there is high current flowing through motor coils (even when motor is at standstill). Pulling or plugging connector P2 with power on will cause extremely high back-EMF voltage surge, which may damage the driver.

9. Typical Connection

A complete stepping system should include stepping motor, stepping driver, power supply and controller (pulse generator). A typical connection is shown as figure 9.

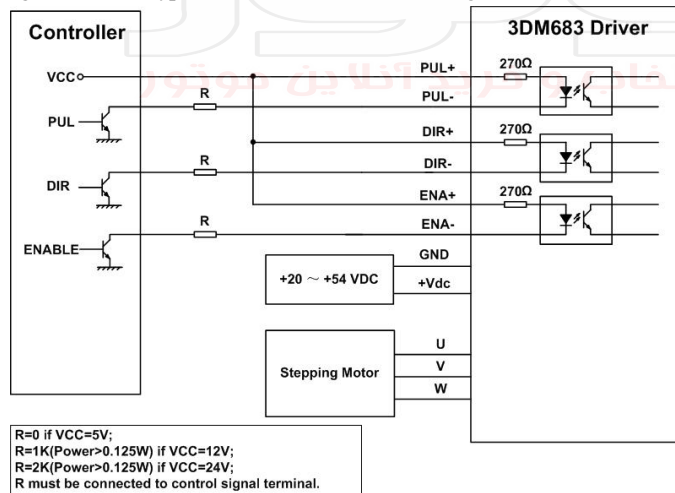

Figure 9: Typical connection

10. Sequence Chart of Control Signals

In order to avoid some fault operations and deviations, PUL, DIR and ENA should abide by some rules, shown as following diagram:

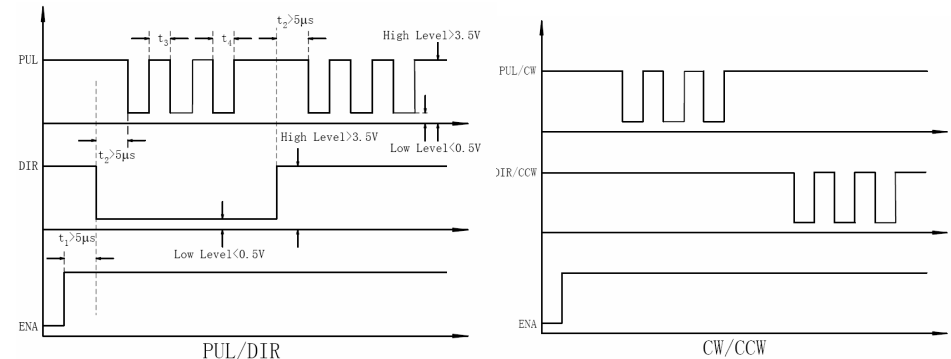

Figure 10: Sequence chart of control signals

Remark:

- a) t1: ENA must be ahead of DIR by at least 5μs. Usually, ENA+ and ENA- are NC (not connected). See “Connector P1 Configurations” for more information.
- b) t2: DIR must be ahead of PUL active edge by 5μs to ensure correct direction;
- c) t3: Pulse width not less than 2.5μs;
- d) t4: Low level width not less than 2.5μs.

11. Protection Functions

To improve reliability, the driver incorporates some built-in protection functions. The 3DM683 uses one RED LED to indicate what protection has been activated. The periodic time of RED is 3 s (seconds), and how many times the RED turns on indicates what protection has been activated. Because only one protection can be displayed by RED LED, so the driver will decide what error to display according to their priorities. See the following **Protection Indications** table for displaying priorities.

Over-current Protection

Over-current protection will be activated when continuous current exceeds the upper limit or in case of short circuit between motor coils or between motor coil and ground, and RED LED will turn on once within each periodic time (3 s).

Over-voltage Protection



When power supply voltage exceeds 62 ± 1 VDC, protection will be activated and RED LED will turn on twice within each periodic time (3 s).

Phase Error Protection

Motor power lines wrong & not connected will activate this protection. RED LED will turn on four times within each periodic time (3 s).

Attention: When above protections are active, the motor shaft will be free or the LED will turn red. Reset the driver by repowering it to make it function properly after removing above problems. Since there is no protection against power leads (+, -) reversal, it is critical to make sure that power supply leads correctly connected to driver. Otherwise, the driver will be damaged instantly.

Protection Indications

| Priority | Time(s) of ON | Sequence wave of RED LED | Description |
|-----------------|---------------|---|-------------------------|
| 1 st | 1 |  | Over-current protection |
| 2 nd | 2 |  | Over-voltage protection |
| 3 rd | 4 |  | Phase error protection |

12. Frequently Asked Questions

In the event that your driver doesn't operate properly, the first step is to identify whether the problem is electrical or mechanical in nature. The next step is to isolate the system component that is causing the problem. As part of this process you may have to disconnect the individual components that make up your system and verify that they operate independently. It is important to document each step in the troubleshooting process. You may need this documentation to refer back to at a later date, and these details will greatly assist our Technical Support staff in determining the problem should you need assistance.

Many of the problems that affect motion control systems can be traced to electrical noise, controller software errors, or mistake in wiring.

Problem Symptoms and Possible Causes

| Symptoms | Possible Problems |
|---|---|
| Motor is not rotating | No power |
| | Microstep resolution setting is wrong |
| | DIP switch current setting is wrong |
| | Fault condition exists |
| Motor rotates in the wrong direction | The driver is disabled |
| | Motor phases may be connected in reverse |
| The driver in fault | DIP switch current setting is wrong |
| | Something wrong with motor coil |
| Erratic motor motion | Control signal is too weak |
| | Control signal is interfered |
| | Wrong motor connection |
| | Something wrong with motor coil |
| Motor stalls during acceleration | Current setting is too small, losing steps |
| | Current setting is too small |
| | Motor is undersized for the application |
| | Acceleration is set too high |
| Excessive motor and driver heating | Power supply voltage too low |
| | Inadequate heat sinking / cooling |
| | Automatic current reduction function not being utilized |
| | Current is set too high |

13. Professional Tuning Software ProTuner

Introduction

This section will provide an overview of connection and basic setup instructions for Leadshine’s digital stepping Driver 3DM683 using the **ProTuner** software. These instructions will walk you through the following steps necessary to start up your Driver and motor. This section is intended for setting up the Driver with the **ProTuner**.

Software Installation

The **ProTuner** is windows based setup software for tuning all the Leadshine’s digital Drivers includes stepping Driver 3DM683. It can run in windows systems, including Win95/Win98/WindowsNT/Windows 2000/Windows XP. And the selected PC should have 1 serial port at least for communicating with the Driver.

Double click “**ProTuner_All_Setup_V1.0.exe**” to begin installing the **ProTuner**. See Figure 11. Click **Next** to enter the “License Agreement” window. See Figure 12.

Note: **ProTuner_All_Setup_V1.0.exe** can be used for all Leadshine digital drives. User can get it from either Leadshine CD or website. Please get the latest version from <http://www.leadshine.com>.

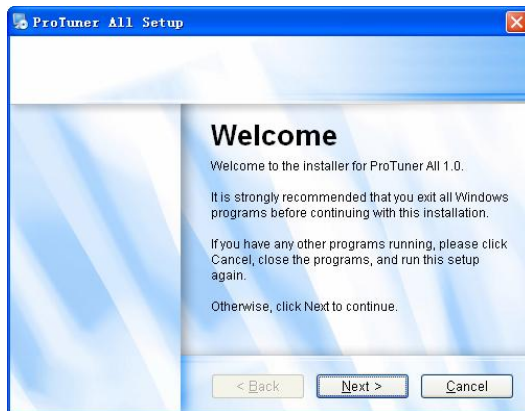

Figure 11: Begin to install the ProTuner

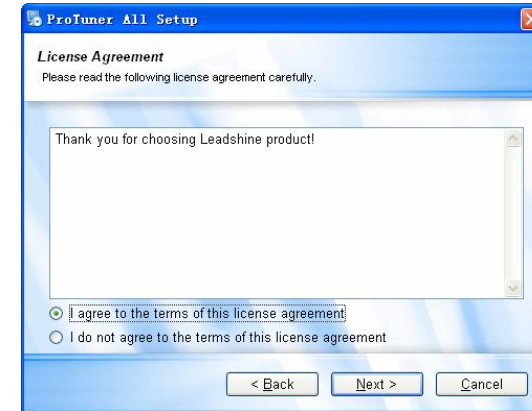

Figure 12: License agreement

Choose “I agree to the terms of this license agreement” and click **Next** to continue installation. The user can enter user’s information in the following window. See Figure 13. After entering the user’s information, click **Next** to select installation folder, where you would like to install the **ProTuner**. See Figure 14.

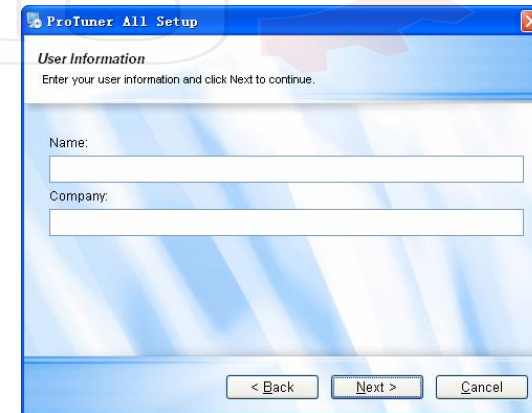

Figure 13: User’s information settings

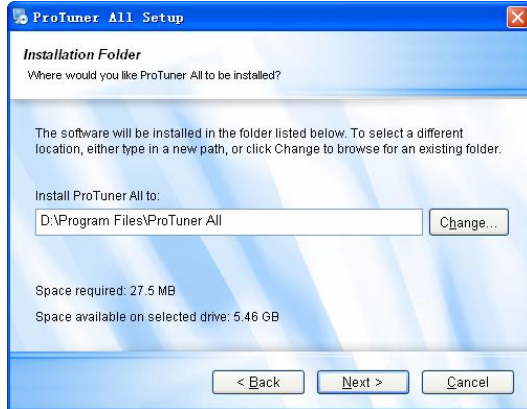

Figure 14: Installation folder settings

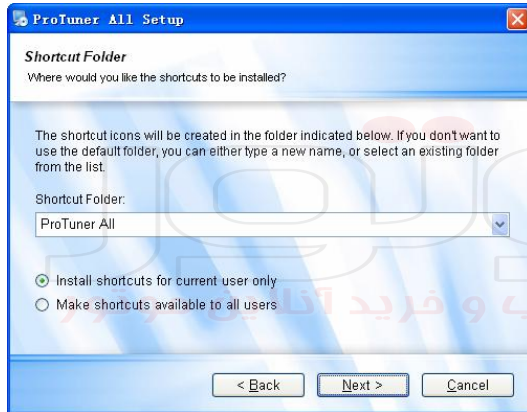

Figure 15: Shortcut folder setting

Set the “Shortcut Folder” in Figure 15 and continue to install the **ProTuner** by following Figure 16 and Figure 17. An **Installation Successful** window will appear if the **ProTuner** is installed successfully. See Figure 18.



Figure 16: Installation information summarization

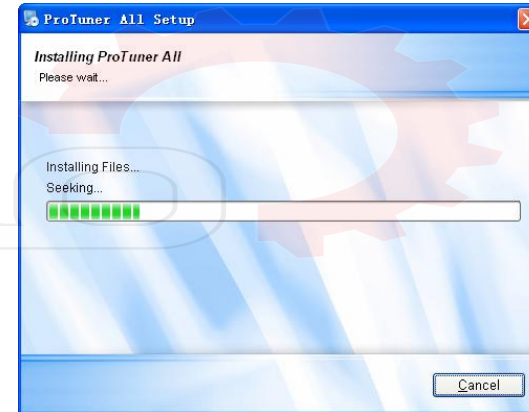

Figure 17: Installing the ProTuner

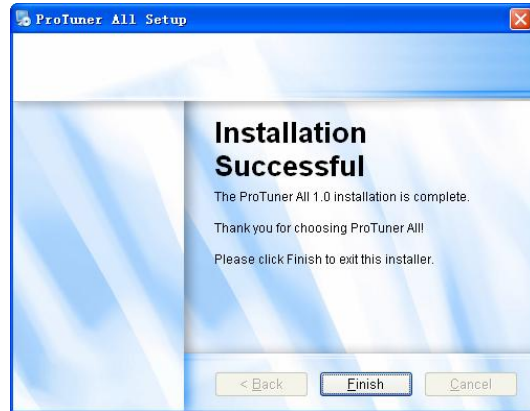

Figure 18: Finish installation

Connections and Testing

Connect the stepping system according to the contents in previous sections and connect the PC to the driver as the following figure.

RS232 Interface Connection

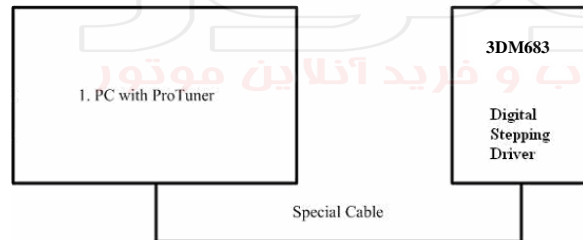

Figure 19: RS232 interface connection

Testing the Stepping System

Turn on the power supply, the green (Power) LED will light. The 3DM683 has default parameters stored in the driver. If the system has no hardware and wirings problem, the motor should be locked and the driver should be ready.

If the red LED immediately turns on (flickers), then check power supply, the motor, motor wirings

and try again. Open the tuning software **ProTuner** and check driver status by clicking **Err_check**. If it's **Phase Error**, check the motor, motor wirings and try again. If it still doesn't work after you followed all of the previous steps, please contact us at tech@leadshine.com.

If the RED LED is off and the motor is normal, then you can start to tune the servo with **ProTuner**. However, we recommend you see the following contents before starting tuning.

Software Introduction

ProTuner Main Window



Figure 20: ProTuner

Ø Option

The user can choose three drop-down menus by clicking "Option", including **Com Config**, **SaveToDriver** and **Exit**.

- I **Com Config:** Configure Com communication interface.
- I **SaveToDriver:** Download the current parameter settings to the driver.

I Exit: Exit the **ProTuner**.
Com Config Window

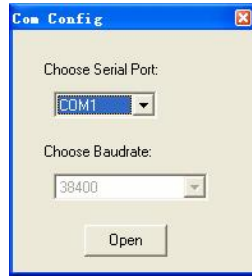

Figure 21: RS232 communication configuration window

Serial Port: Select the serial communication port to which the driver is connected. The factory default setting is COM1.

Baud Rate: Select the communication baud rate. The factory default setting is 38400.

Click **Open** button to establish a connection with the specified settings. When connecting, you can choose **SaveToDrive** to download the current parameter settings to the driver, or to upload the stored driver settings into the **ProTuner** by clicking **Tuning > Position Loop** on the menu bar.

Tuning

The user can choose one or two drop-down menu(s) by clicking **Tuning**, including **CurrentLoop** and **SystemConfig**.

I CurrentLoop: In Current Tuning window, the user can tune the **Kp (Proportional Gain)** and **Ki (Integral Gain)** of driver's current loop to optimize responses with different motors. Start/Restart a Step Response test to get an optimum response.

Kp: Proportional Gain. Proportional Gain determines the response of the driver to current setting command. Low Proportional Gain provides a stable system (doesn't oscillate), has low stiffness, and large current error, causing poor performances in tracking current setting command in each step like Figure 23. Too large Proportional Gain values will cause oscillations and unstable systems.

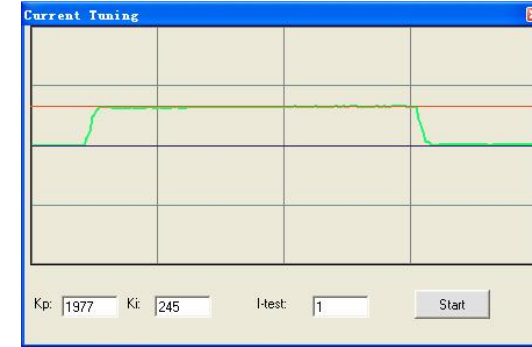

Figure 22: Current Tuning window

Ki: Integral Gain. Integral Gain helps the driver to overcome static current errors. A low or zero value for the Integral Gain may have current errors at rest. Increasing the Integral Gain can reduce the error. If the Integral Gain is too large, the systems may "hunt" (oscillate) about the desired position.

Start button: The user can start a Step Response test by clicking this button. Start/Restart a Step Response test to get an optimum response like Figure 22, and remember to save the settings to the driver when finish tuning. See Figure 24.

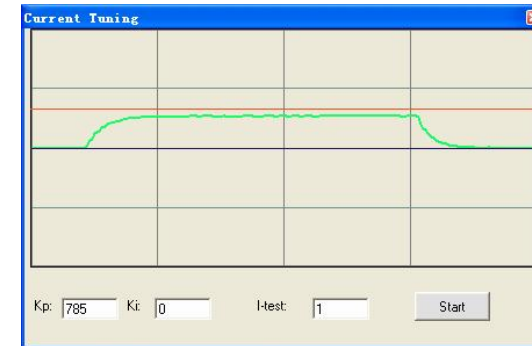

Figure 23: Kp=785, Ki=0 (poor performances)

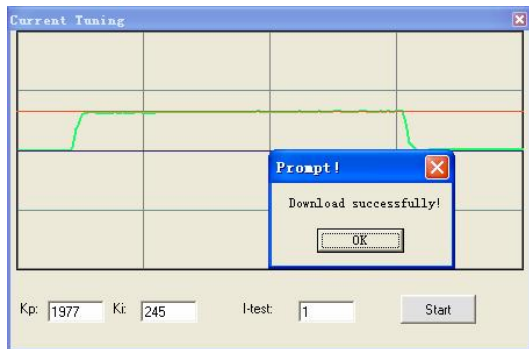

Figure 24: Finish tuning and save setting to the driver

Notes:

However, if the user does not want to tune the current loop after changing a different stepping motor, then **Motor auto-identification and parameter auto-configuration** technology of the 3DM683 can replace manual tuning the driver with **ProTuner**. Just changes SW4 two times in 1 second, and then the driver will auto-identify the new motor and auto-configure related control parameters for optimum responses. **Recommend** use this function after changing the driven motor.

1 SystemConfig:

In **SystemConfig** window, the user can configure Peak Current, Microstep, Command Type, Active Edge, and eliminate motor resonance. A built-in pulse generator can be used for test during tuning. See Picture 25.

PeakCur: Peak Current. The value is the peak current to the selected motor and can be set from 0.5 to 8.3 A. The user can set the peak current with **ProTuner** or DIP switches, see more information about setting output current of the driver in section 5 “**Connecting the Motor**” and section 7 “**Selecting Microstep Resolution and Driver Output Current**”.

MicroStep: Microstep Resolution. The value is driver’s microstep resolution setting and can be set from 1 to 512. The user can set the microstep with **ProTuner** or DIP switches, See more information about setting output current of the driver in section 7 “**Selecting Microstep Resolution and Driver Output Current**”.

ElecDamp: Electronic Damping Coefficient. The electronic damping restrain resonance of the

system and prevent amplitude of the oscillation from increasing to the extend that it makes the motor out of control. The optimal value depends on the system, and the default value is 3000.

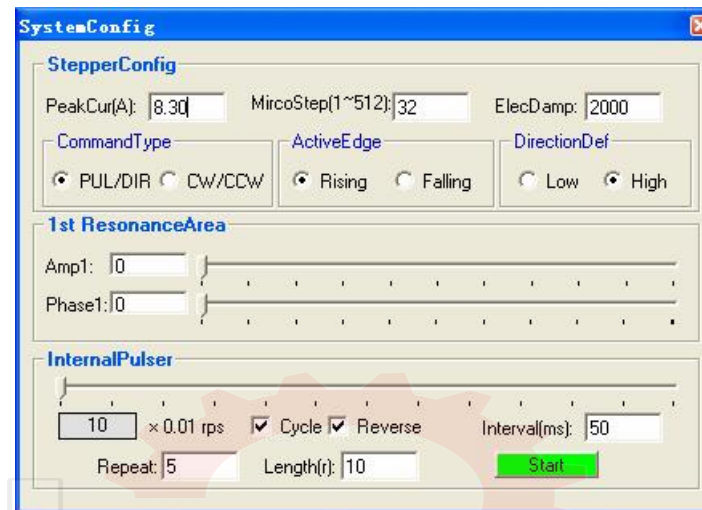

Figure 25: SystemConfig window

CommandType: Command Type of control signal, including PUL/DIR and CW/CCW. Set this parameter according to **Command Type** of motion controller.

ActiveEdge: Active Edge. The user can set the triggered edge of pulse command signal in this panel. When the driver works in CW/CCW mode, no matter what level is at fixed level terminal, the driver can works properly.

DirectionDef: Direction Definition. Relate the default running direction to a **HIGH** level input in DIR or **Low** level input in DIR. This panel is used for PUL/DIR command type only. Please note that the default direction is also related to motor coil connections.

Anti-Resonance Introduction

Step motors are highly resonant, which results in vibration and ringing. The ringing utilizes a large fraction of the motor's available torque – thereby wasting performance. Furthermore, at mid-range velocities, the resonance can become so severe that the motor loses synchronization and stalls. The

3DM683 driver provides robust anti-resonance control to stop the vibrations and maintain equilibrium. This feature requires that the driver be configured with respect to the total inertia in the system. If set improperly, the effectiveness of the feature may be diminished.

The user can invoke or disable the feature by setting **Amp** and **Phase** values in **SystemConfig** window. **Amp** and **Phase** values all zero is to disable the feature, otherwise is to invoke the feature. It should be enabled unless the system configuration either does not need it or cannot tolerate it. A system with loose couplings or viscous loading generally does not need this feature. If a system has compliant (springy) coupling and is absent appreciably viscosity, it may not respond well to the active, anti-resonant loop in the drive. The anti-resonant feature is not designed to damp such a 4th order system. If the application of anti-resonance results in degradation or instability, it should be disabled.

1st ResonanceArea: Parameters for 1st resonance area. Usually between 0.6rps and 2rps.

Amp1 is Amplitude adjustment for 1st resonance area.

Phase1 is Phase adjustment for 1st resonance area. The user can enter a value directly in the text box or move the slider bar back and forth to get an optimum value.

InternalPulser: There is an internal pulse generator designed for driver self-testing and anti-resonance tuning. You can issue a motion by this simple controller.

Cycle check box: The motor will run in double direction if this box is checked.

Reverse check box: Used to reverse the initial running direction..

Interval edit box: Holding time between each repeat, unit is **millisecond**.

Repeat edit box: Total motion repeats.

Length edit box: Journey of each motion, unit is **revolution**.

Start/Stop button: The user can Start/Stop a motion test by clicking this button.

Procedure for Achieving Optimum Performance

Step 1: Start the motion test by clicking **Start/Stop** button. Find a resonance speed by slightly moving the slider bar of internal pulse generator back and forth. See Figure 26.

Step 2: Run the motor at the resonance speed and verify the motor smoothness. You may find a better smoothing value by slightly moving the slider bars of **AMP(s)** and **Phase(s)** back and forth.

It is very important to make the **AMP(s)** and **Phase(s)** adjustments at the proper test speeds with an unloaded motor. Running at an incorrect test speed will not excite the motor at its peak resonance,

making it more difficult to find proper adjustment values. Optimum **AMP(s)** and **Phase(s)** values may be a little different between running the tests with an unloaded motor and a load motor.

Please remember to click **SavetoDrive** to download the final parameter settings to the driver when finish tuning. See Figure 27.

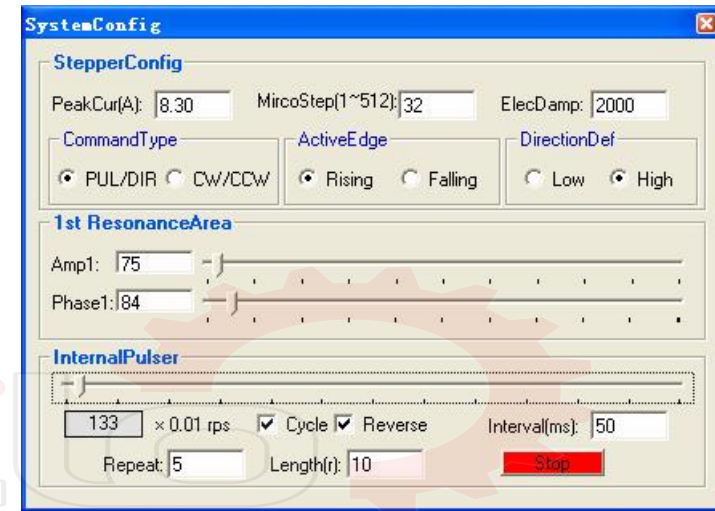

Figure 26: Anti-resonance tuning

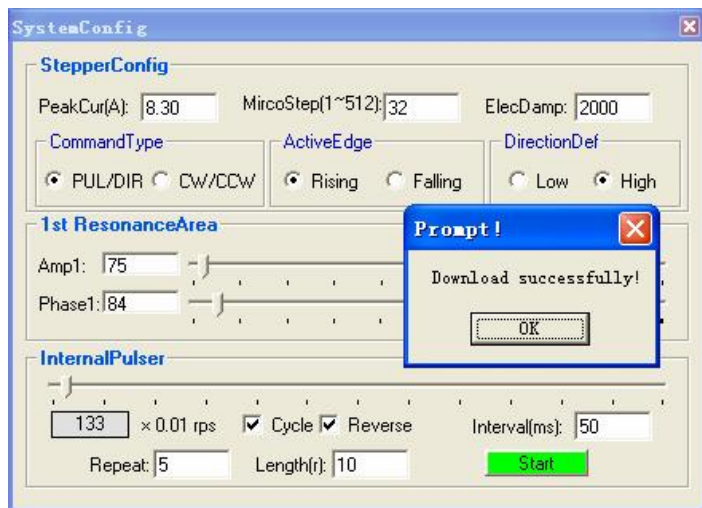

Figure 27: Finishing tuning and download parameter settings to the driver

Ø Err_check

I **Error Check:** This window shows both the present status of each error event and their history. Current error event(s) can be reset by clicking **Erase Current Err!** button, and all error events can be reset by clicking **Erase All!** button. List of the last ten drive faults. #0 being the most recent, #9 is the oldest. See Figure 28.

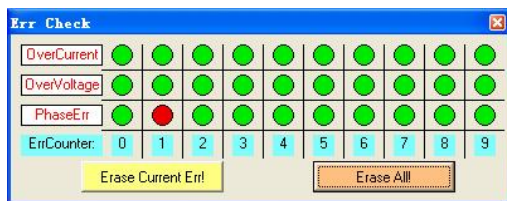

Figure 28: Error check window

OverCurrent: Over-current Protection. Protection will be activated when continuous current exceeds the upper limit.

OverVoltage: Over-voltage Protection. When power supply voltage exceeds 62 ± 1 VDC, protection will be activated.

PhaseErr: Phase Error Protection. Motor power lines wrong & not connected will activate this

protection.

ErrCounter: Displays current error(s) and current error history.

Erase Current Err!: Erase Current Err button. The user can clear current error(s) by clicking this button.

Erase All!: Erase All! button. The user can clear all error(s) including error history by clicking this button.

Ø About

The user can choose two drop-down menus by clicking “About”, including **Product Information** and **Contact Us**.

I **Product Information** window: Shows some product information about ProTuner.

I **Contact Us** window: Shows some contact information about Leadshine.



Figure 29: Product information



Figure 30: Contact information

APPENDIX

Twelve Month Limited Warranty

Leadshine Technology Co., Ltd. warrants its products against defects in materials and workmanship for a period of 12 months from shipment out of factory. During the warranty period, Leadshine will either, at its option, repair or replace products which proved to be defective.

Exclusions

The above warranty does not extend to any product damaged by reasons of improper or inadequate handlings by customer, improper or inadequate customer wirings, unauthorized modification or misuse, or operation beyond the electrical specifications of the product and/or operation beyond environmental specifications for the product.

Obtaining Warranty Service

To obtain warranty service, a returned material authorization number (RMA) must be obtained from customer service at e-mail: tech@leadshine.com before returning product for service. Customer shall prepay shipping charges for products returned to Leadshine for warranty service, and Leadshine shall pay for return of products to customer.

Warranty Limitations

Leadshine makes no other warranty, either expressed or implied, with respect to the product. Leadshine specifically disclaims the implied warranties of merchantability and fitness for a particular purpose. Some jurisdictions do not allow limitations on how long and implied warranty lasts, so the above limitation or exclusion may not apply to you. However, any implied warranty of merchantability or fitness is limited to the 12-month duration of this written warranty.

Shipping Failed Product

If your product fail during the warranty period, e-mail customer service at tech@leadshine.com to obtain a returned material authorization number (RMA) before returning product for service. Please include a written description of the problem along with contact name and address. Send failed product to distributor in your area or: Leadshine Technology Co., Ltd. 3/F, Block 2, Nanyou Tianan Industrial Park, Nanshan Dist, Shenzhen, China. Also enclose information regarding the circumstances prior to product failure.